

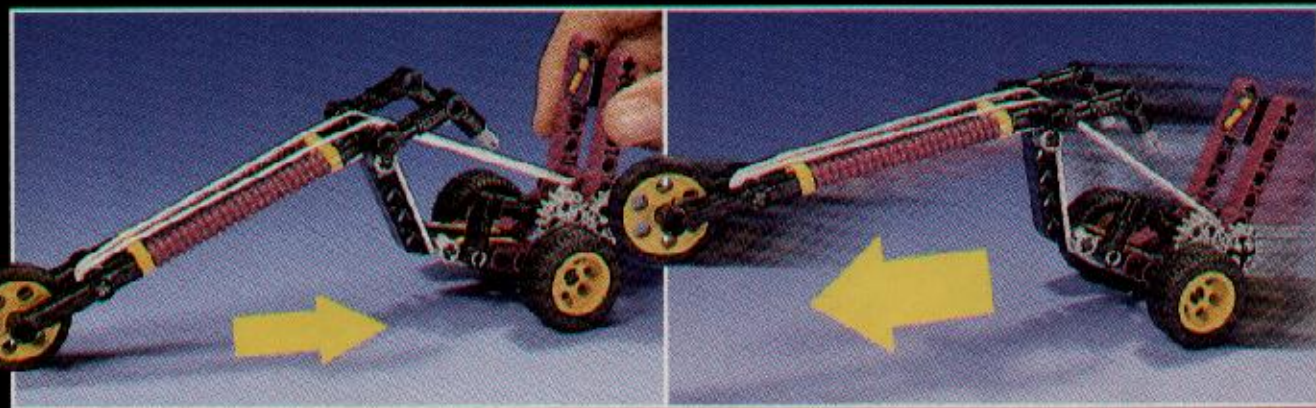

Technic

2854-1

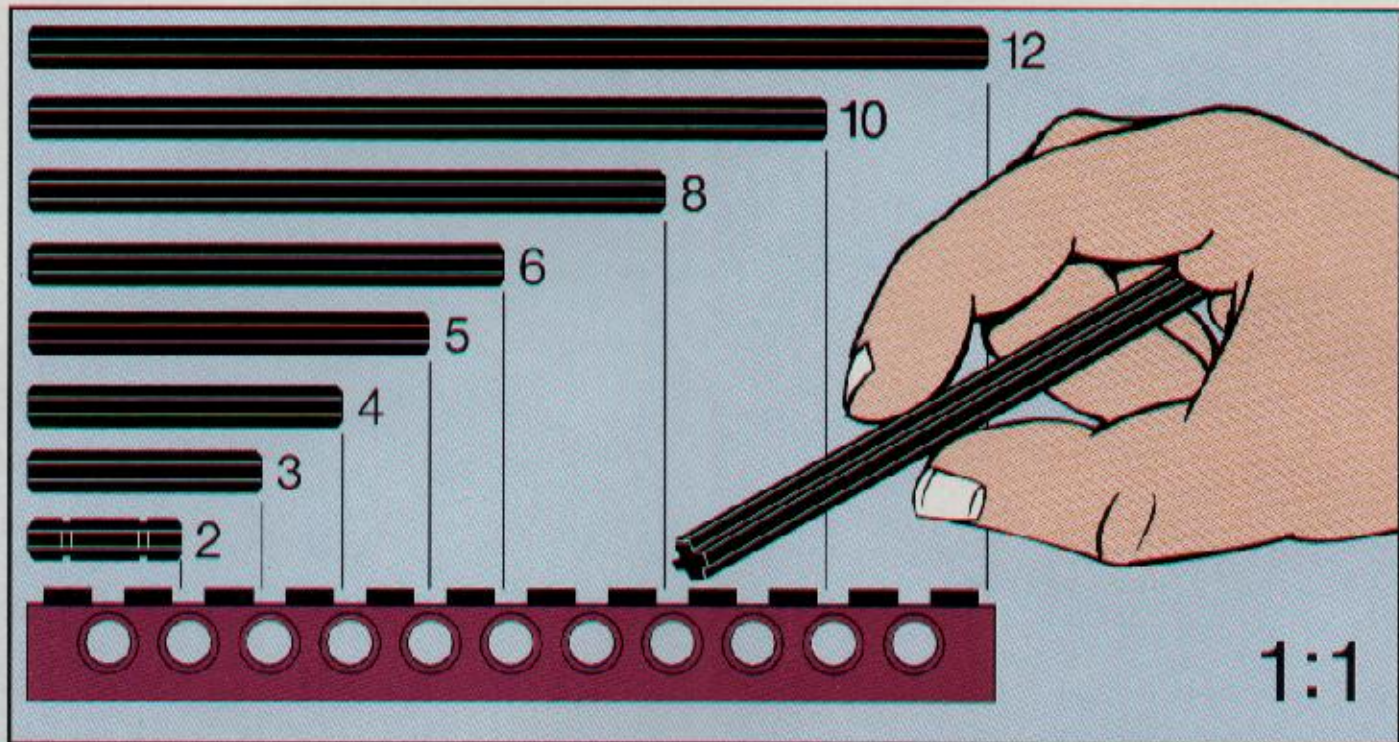



1



2



3

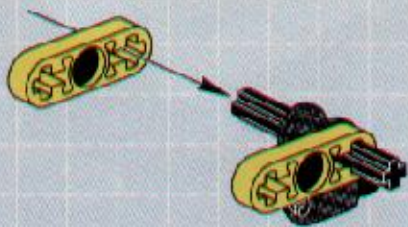

4

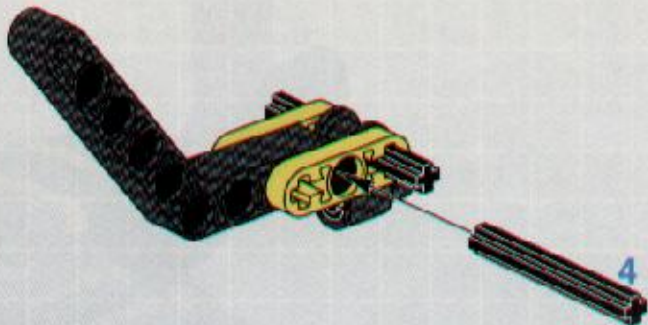

5

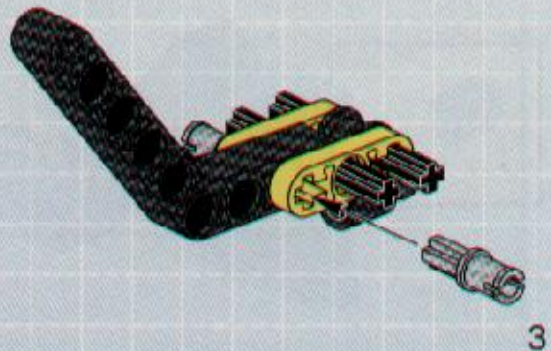

3

6

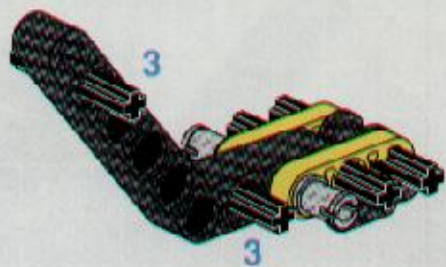

7

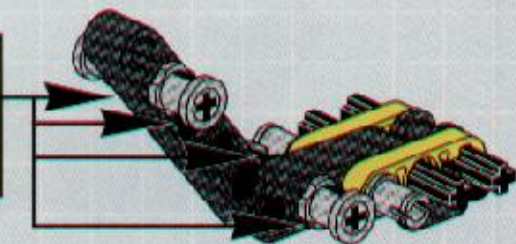
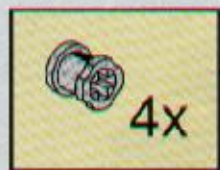

4

8

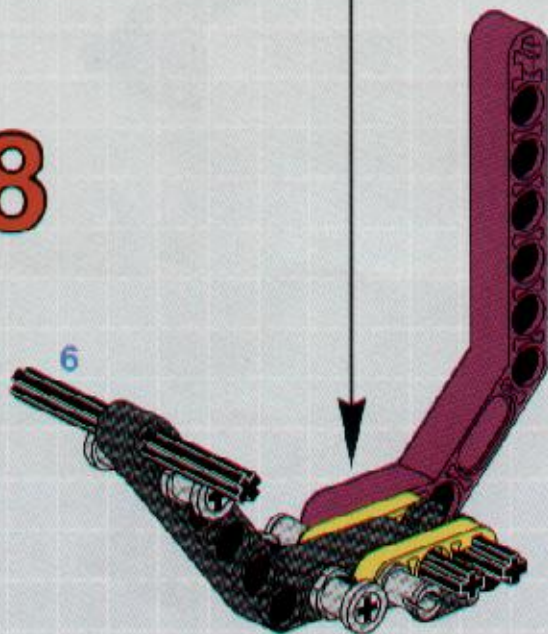
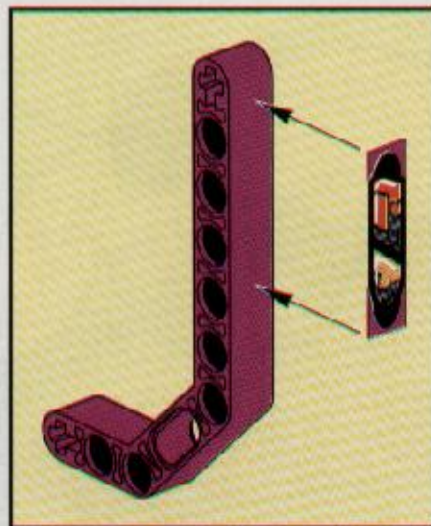

9

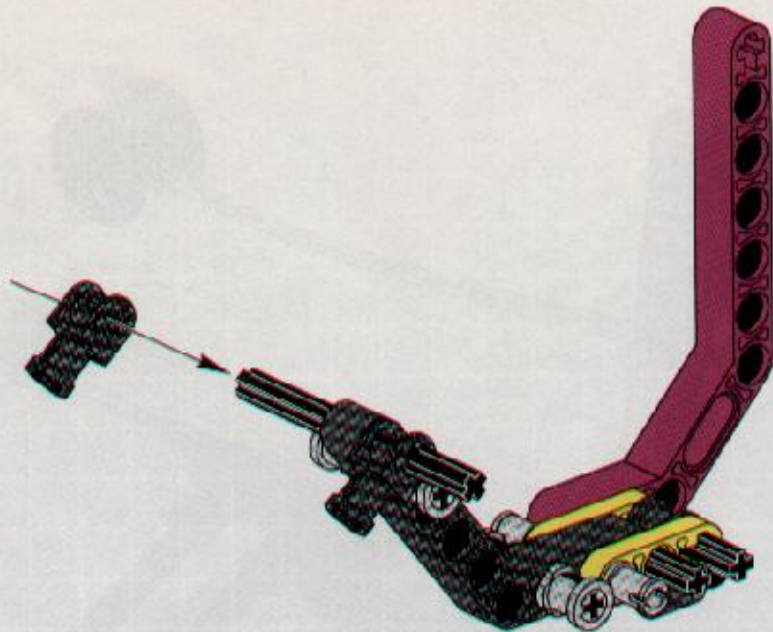

10

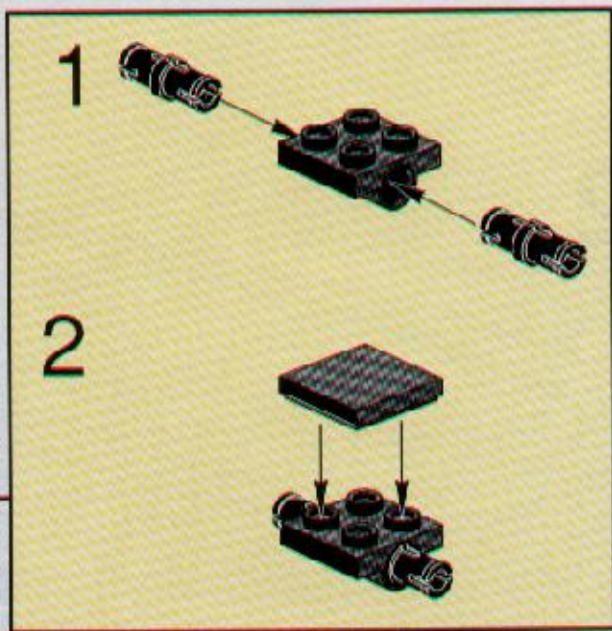
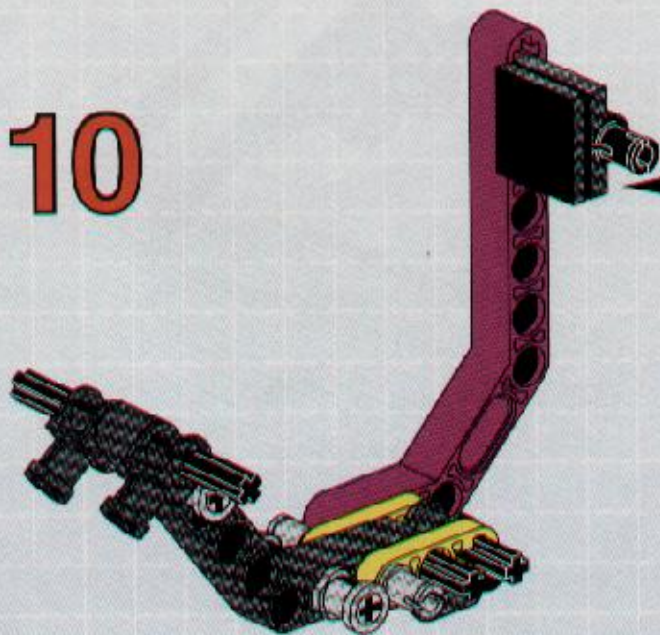

1

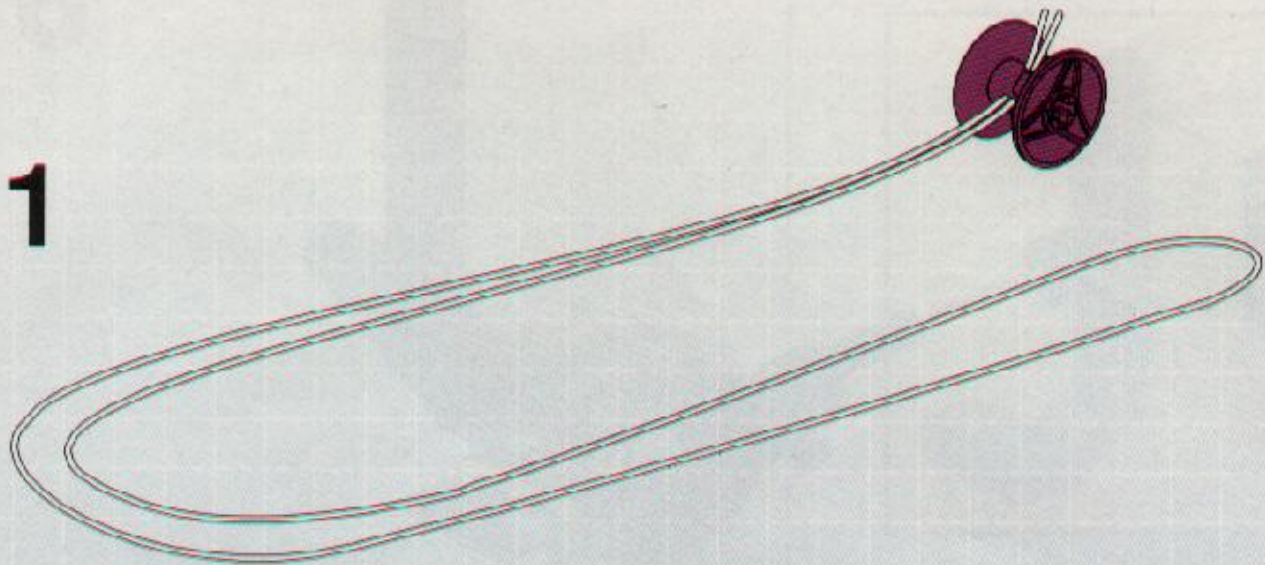

2

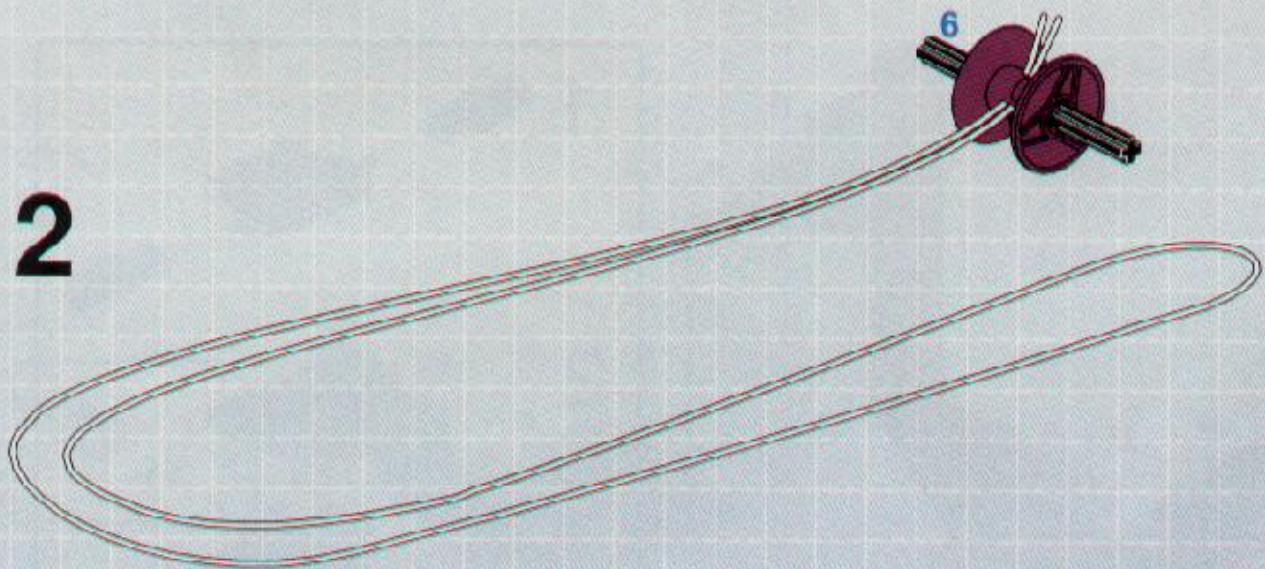

11

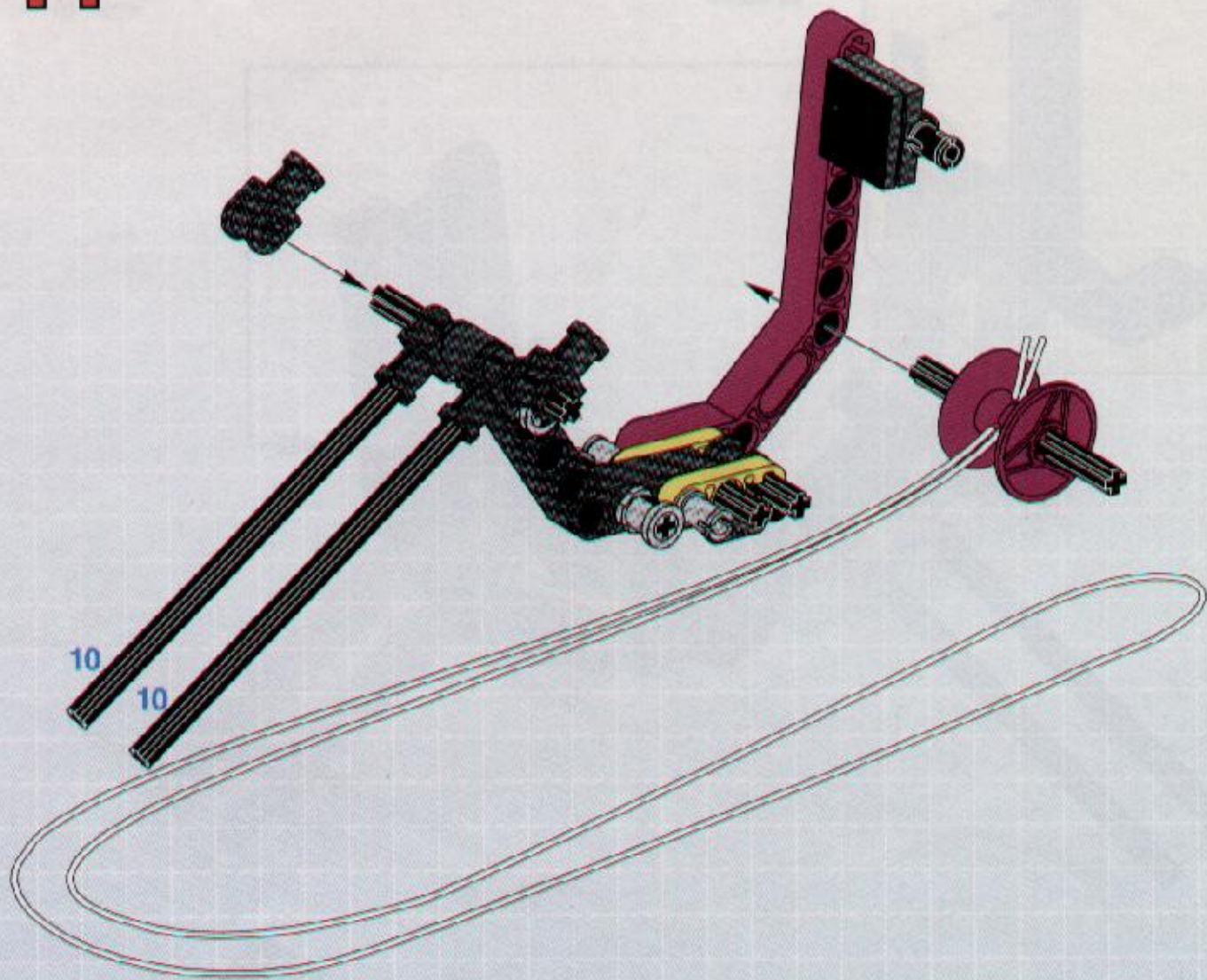

12

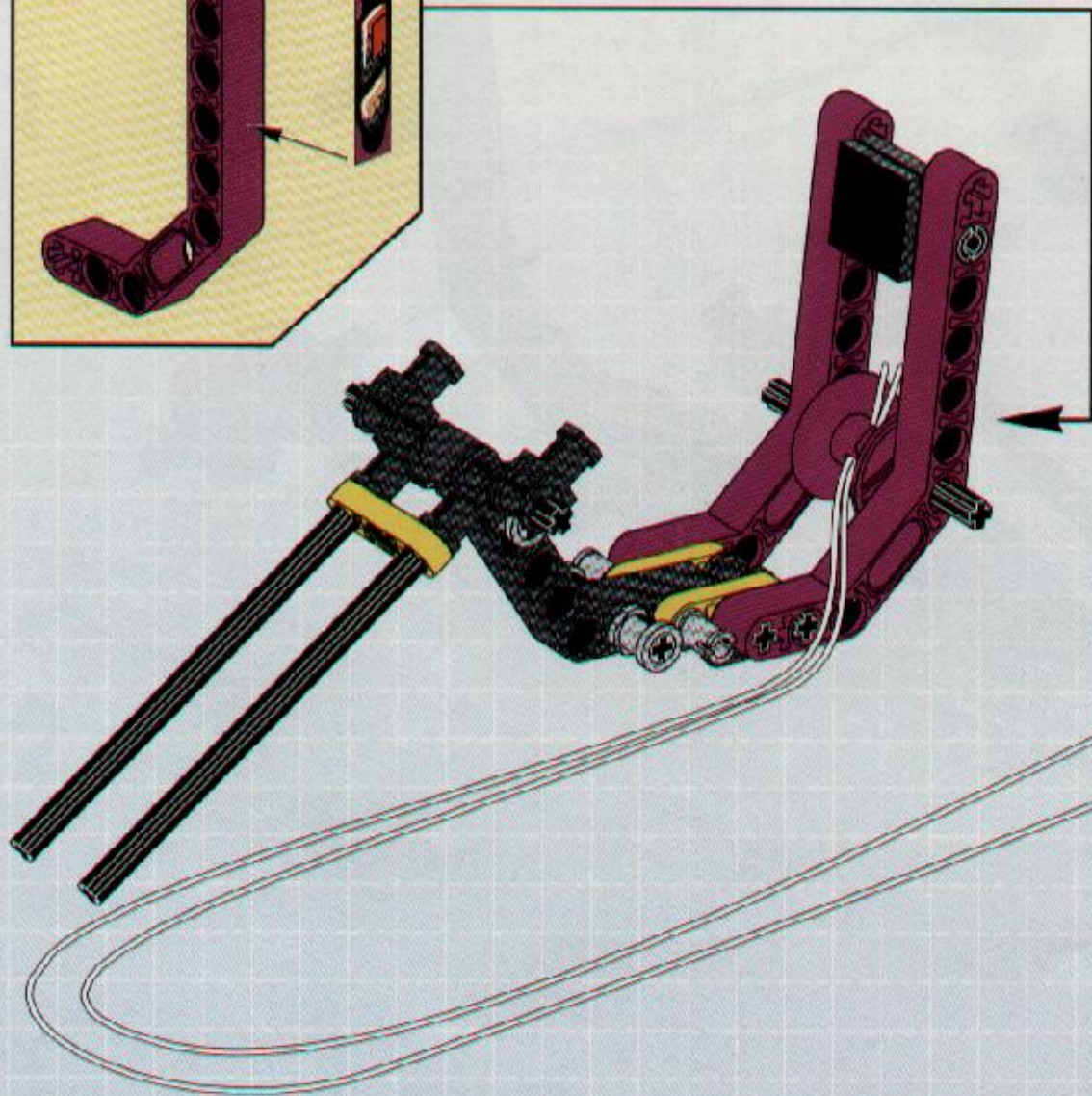
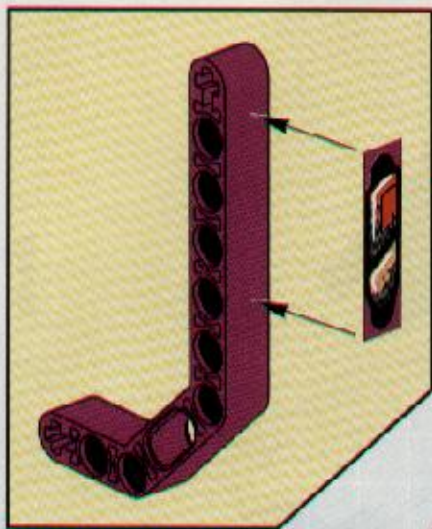

13

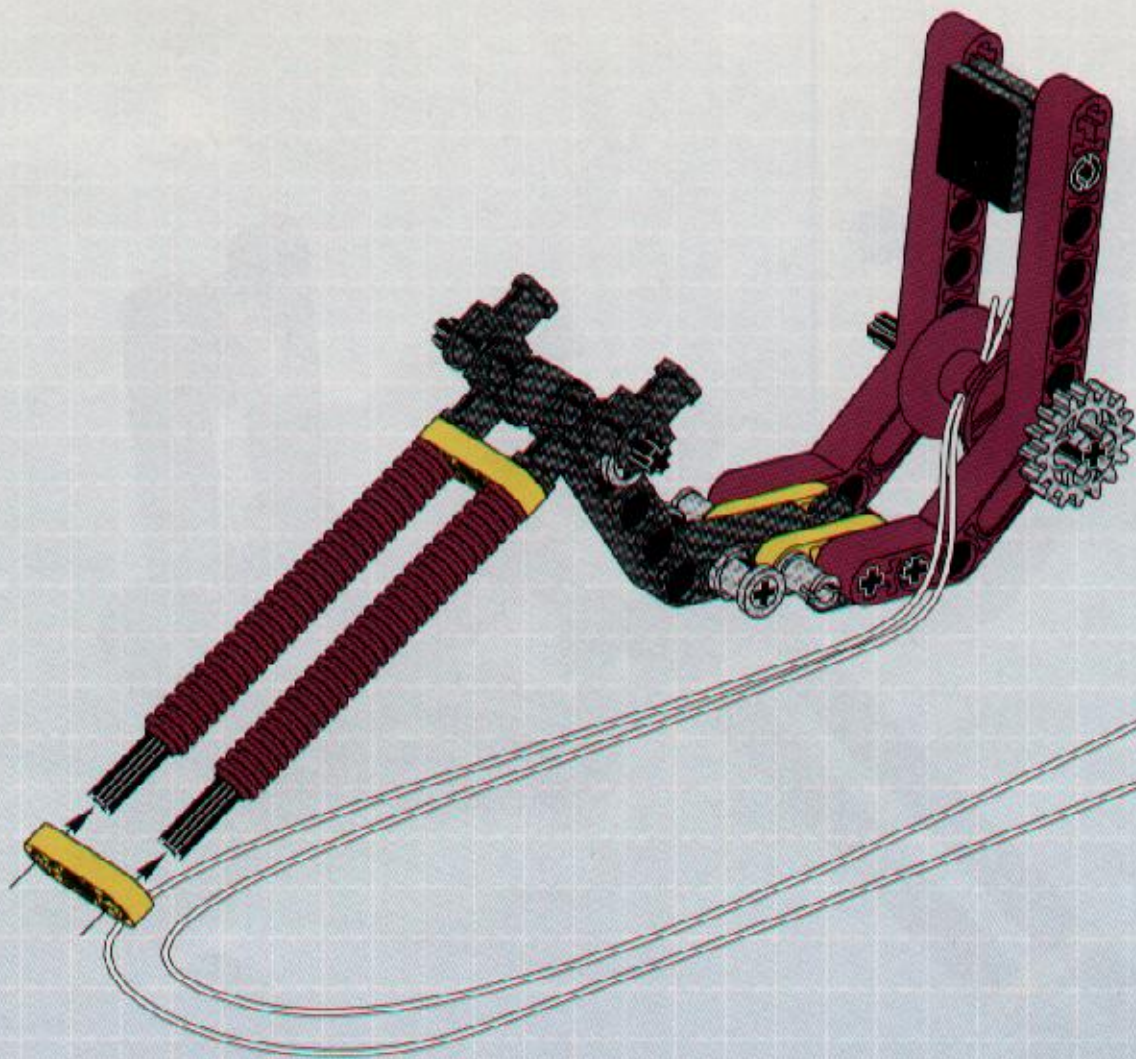

14

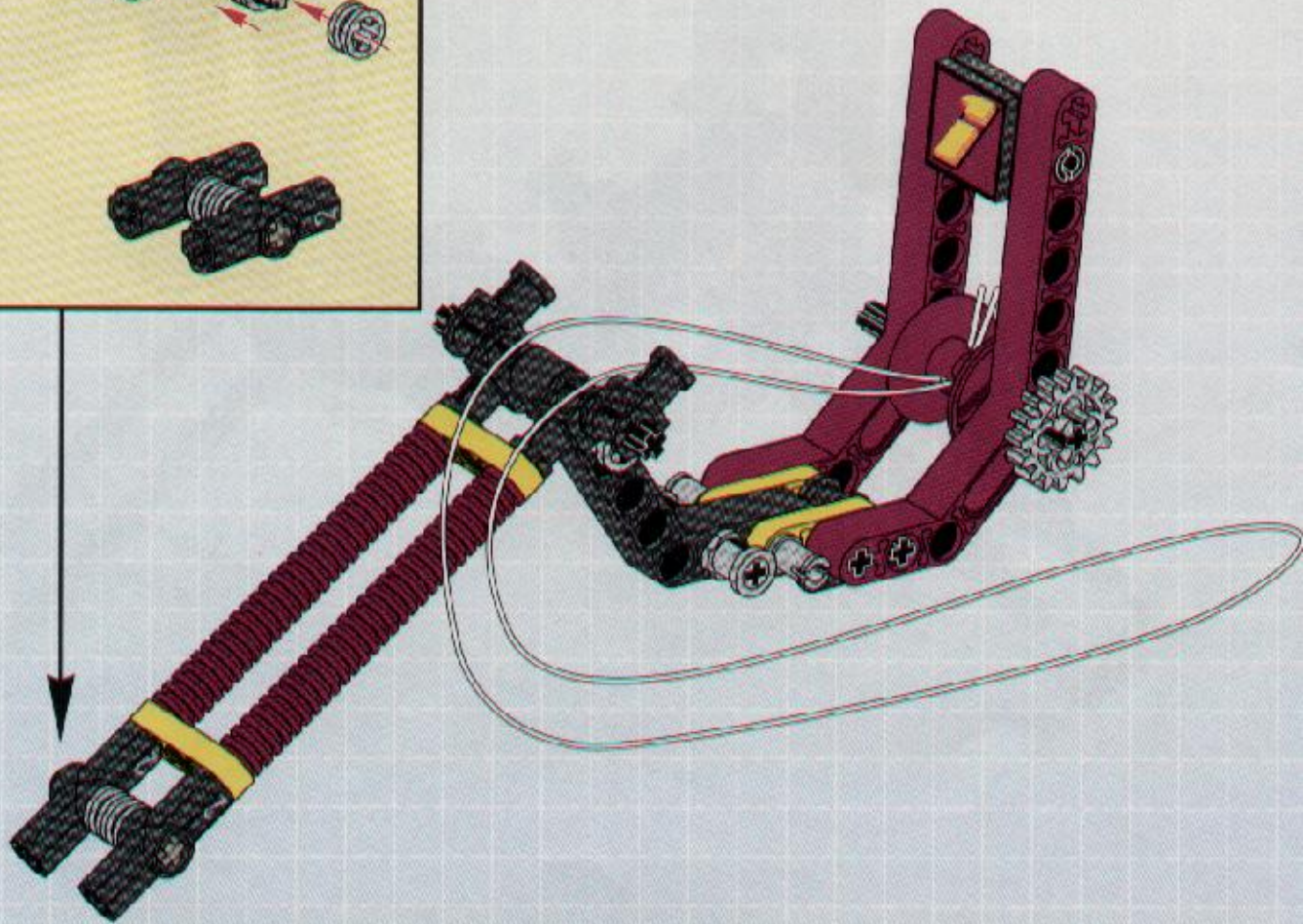
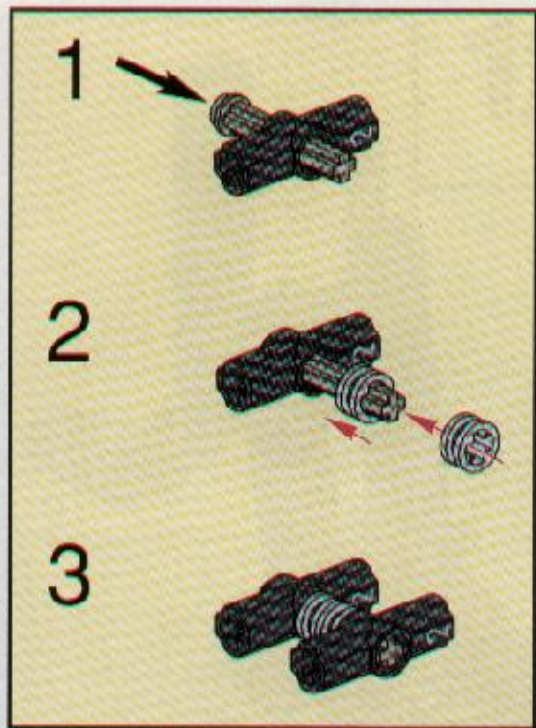

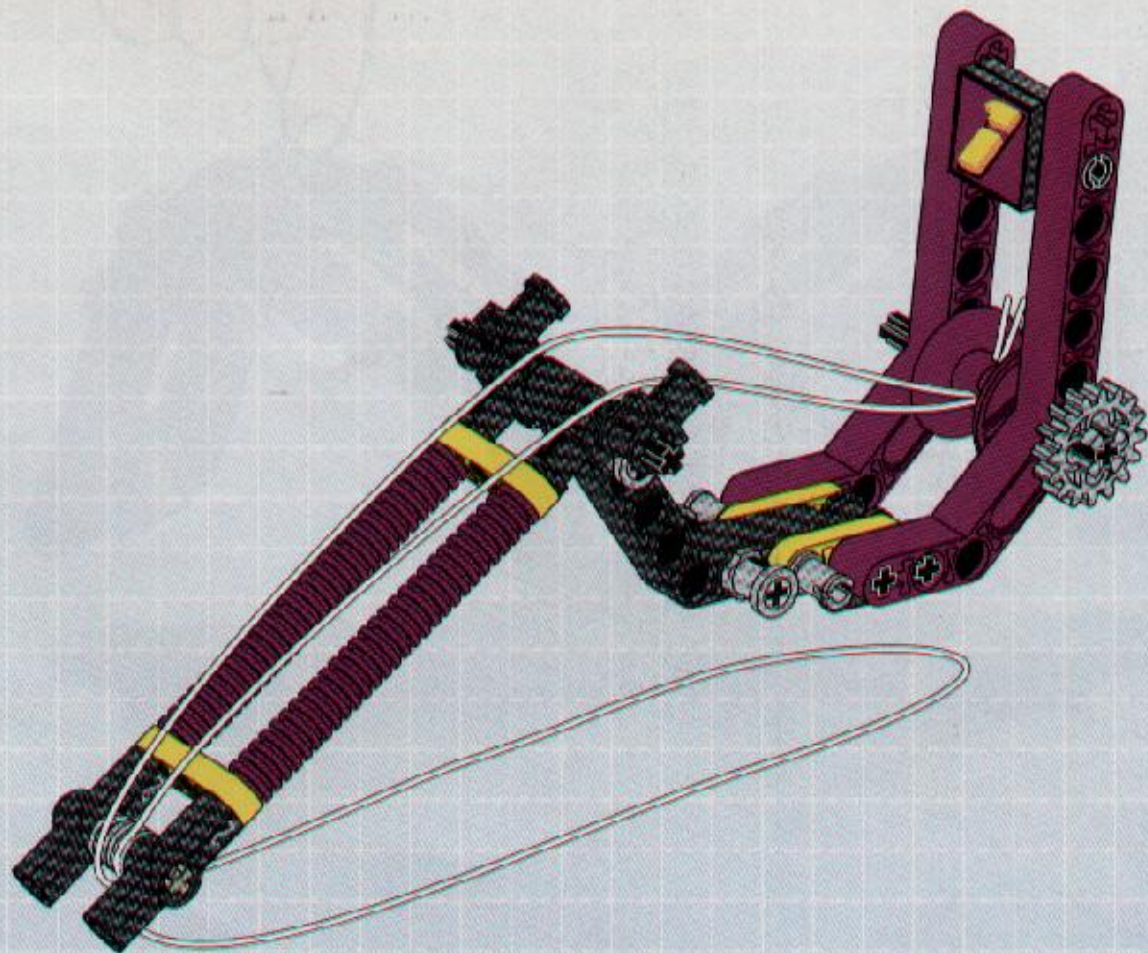

16

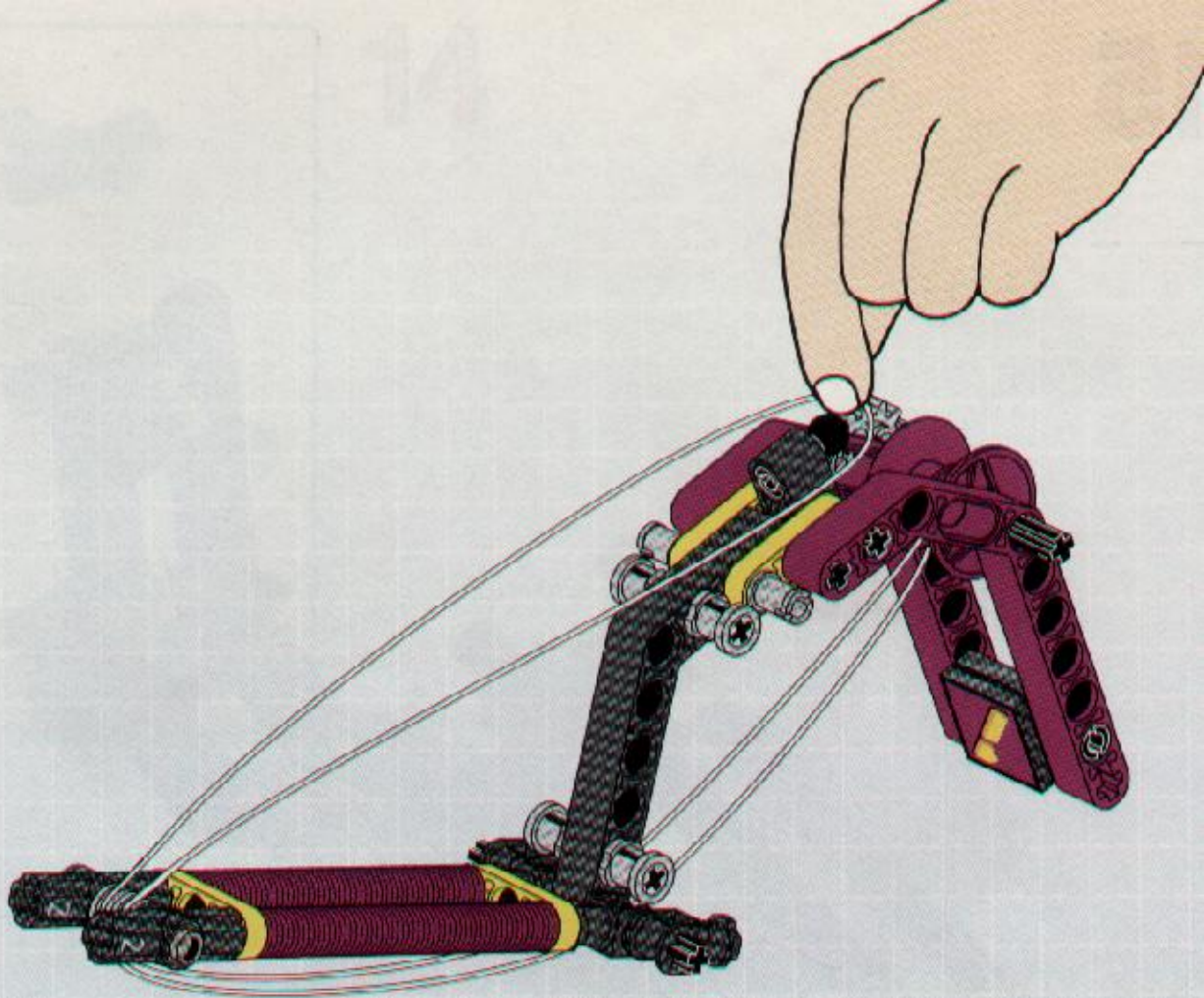

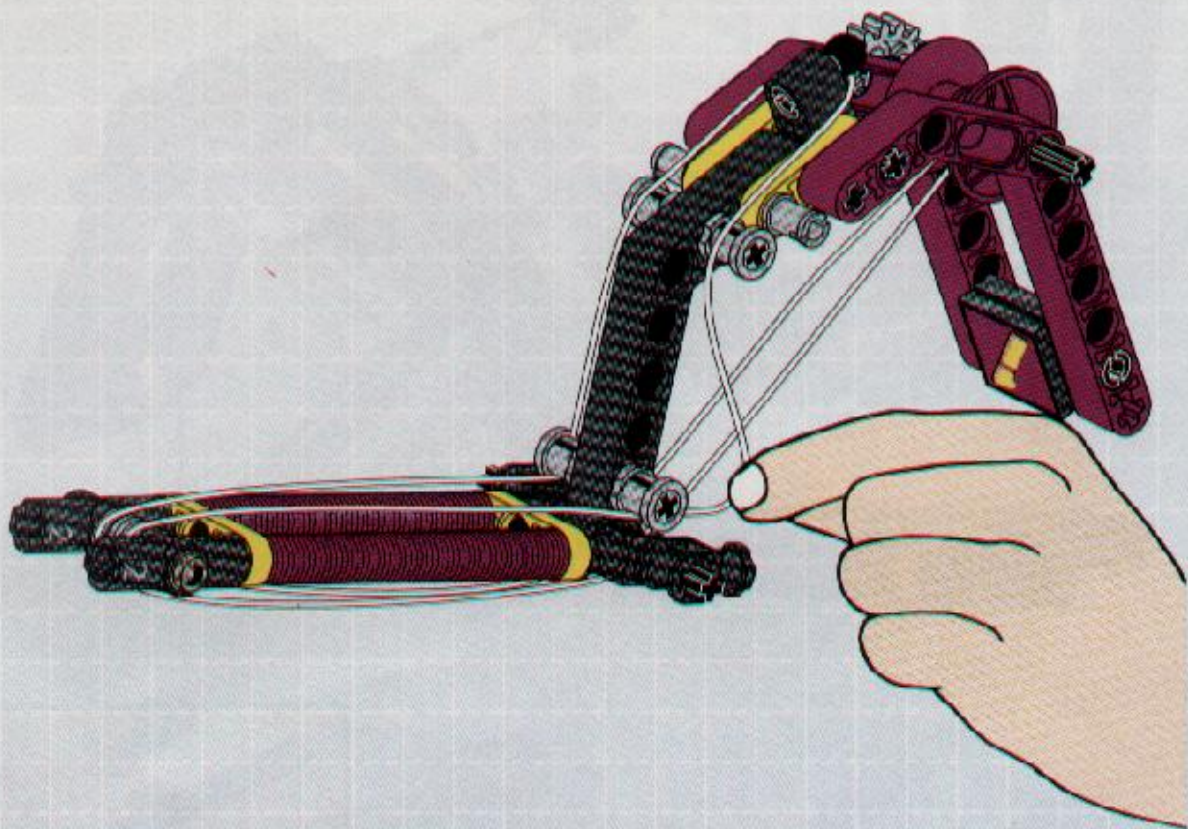

18

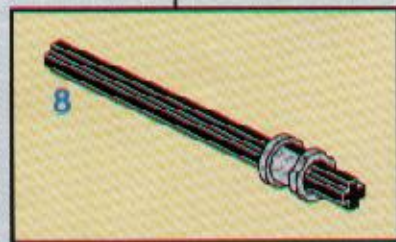
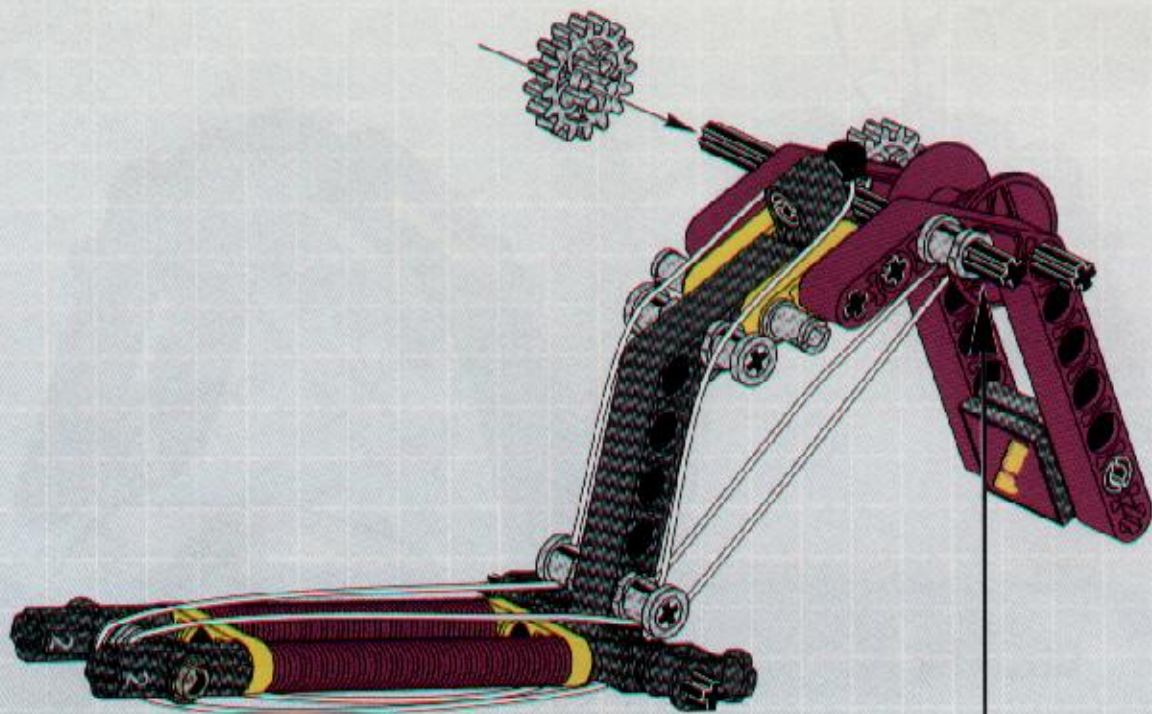

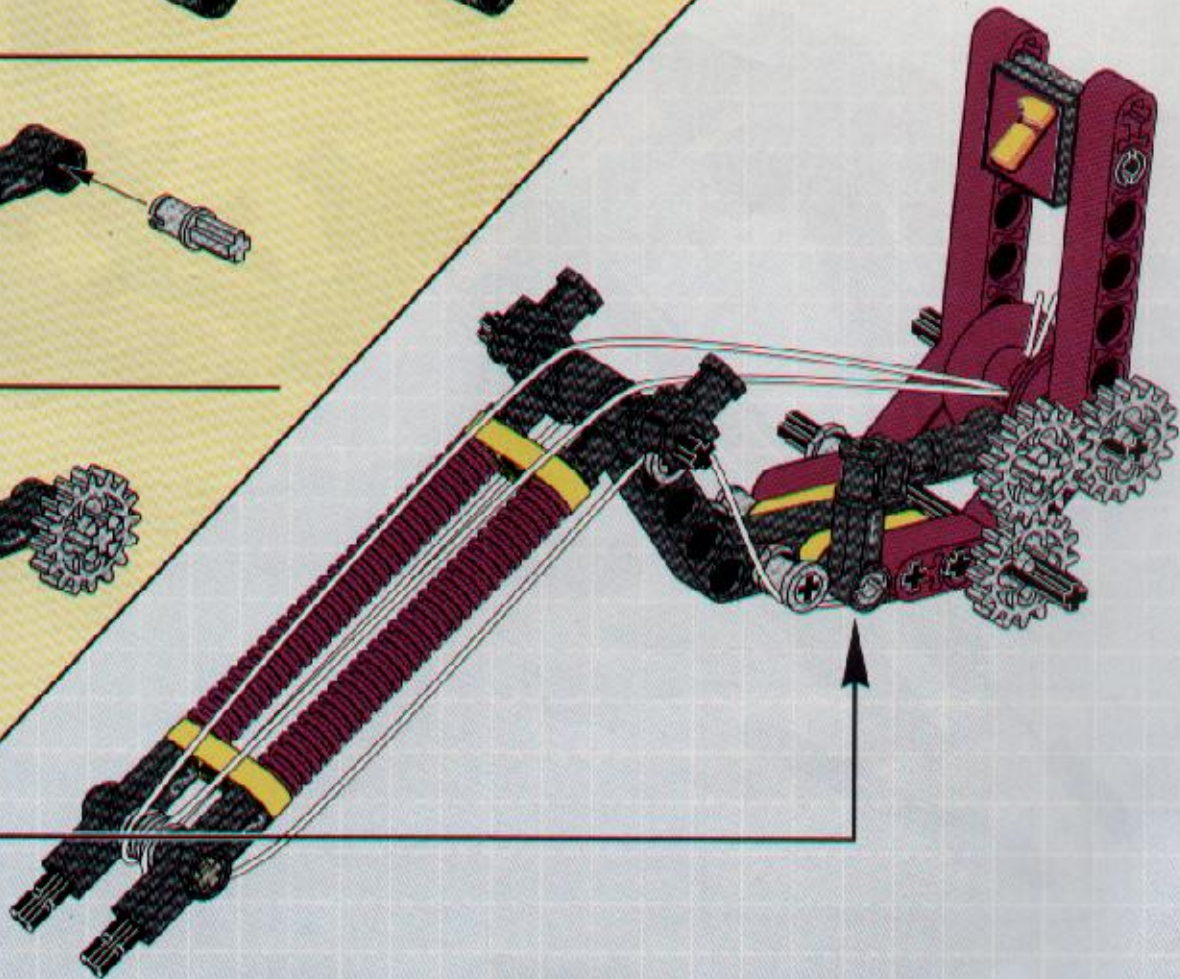
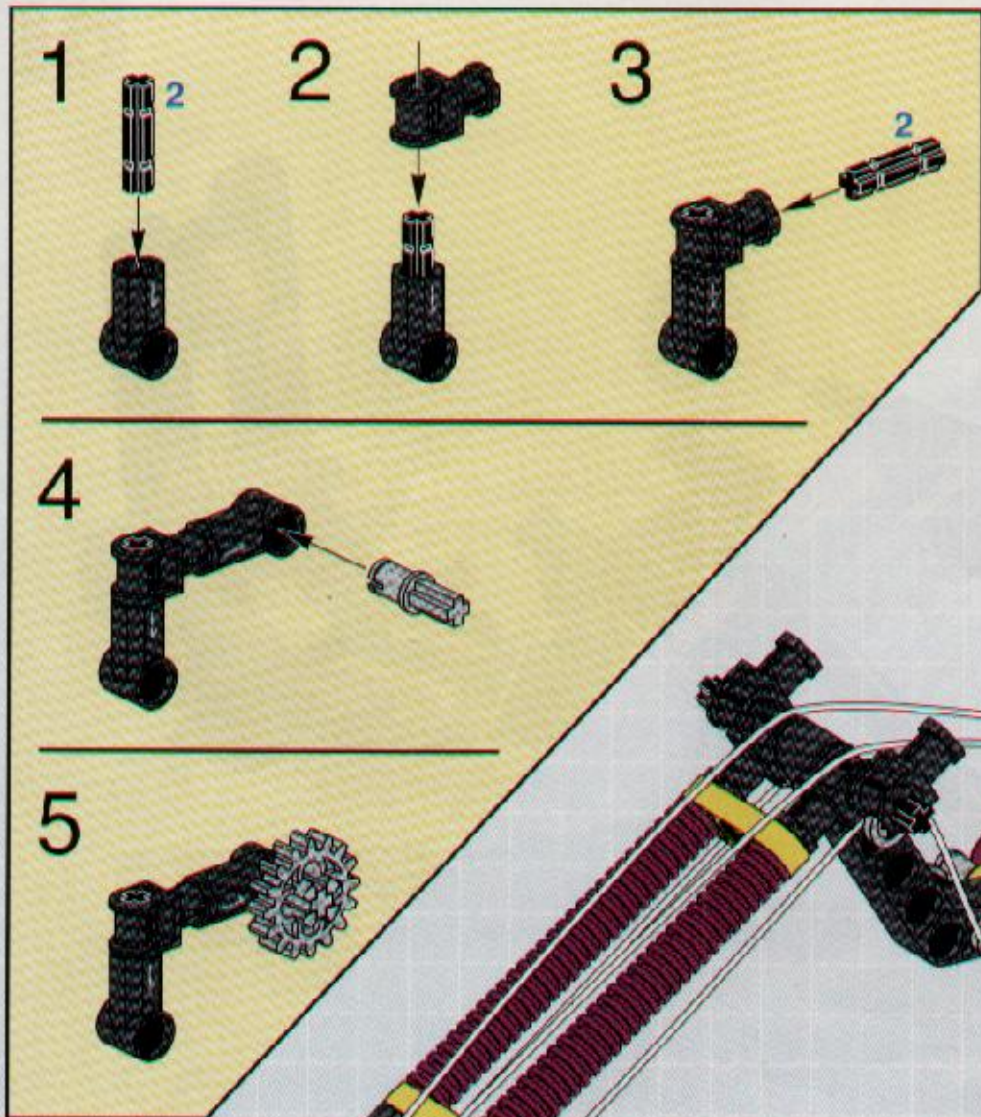

21

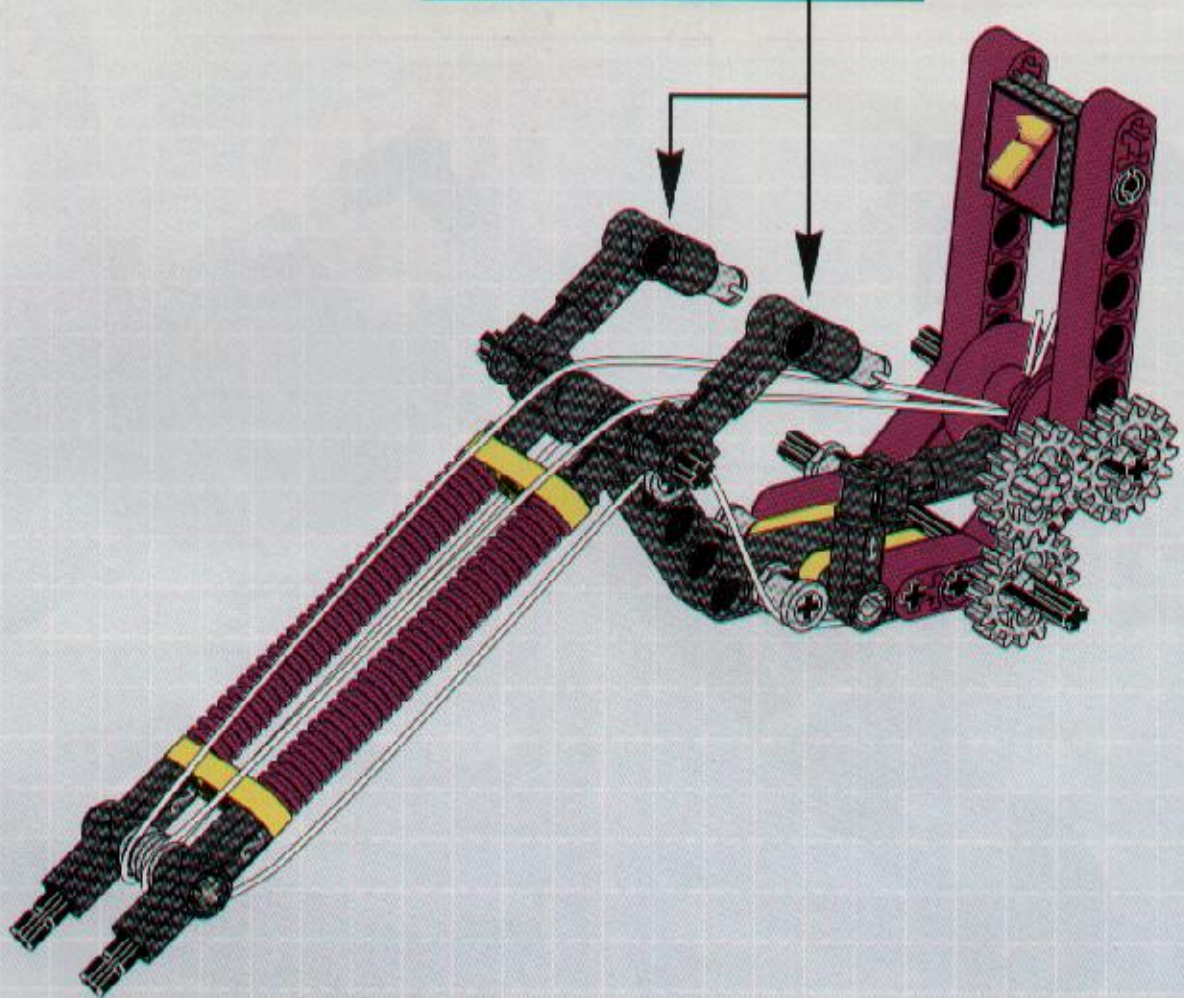
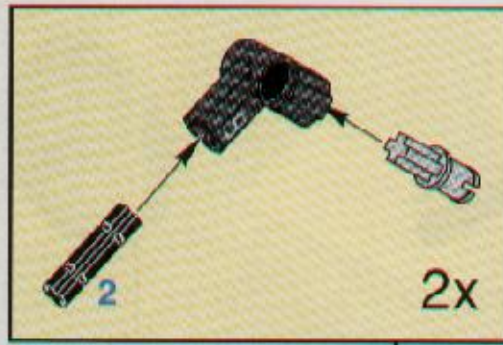

1

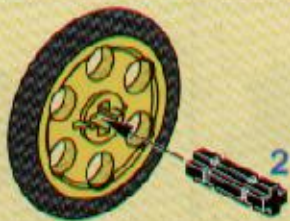

2

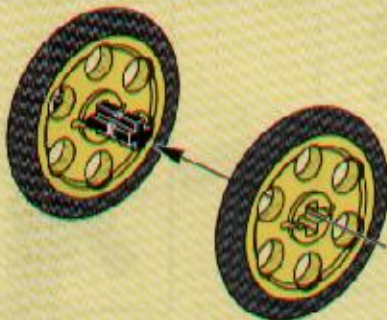

3

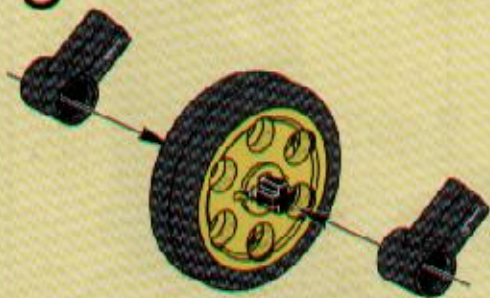

22

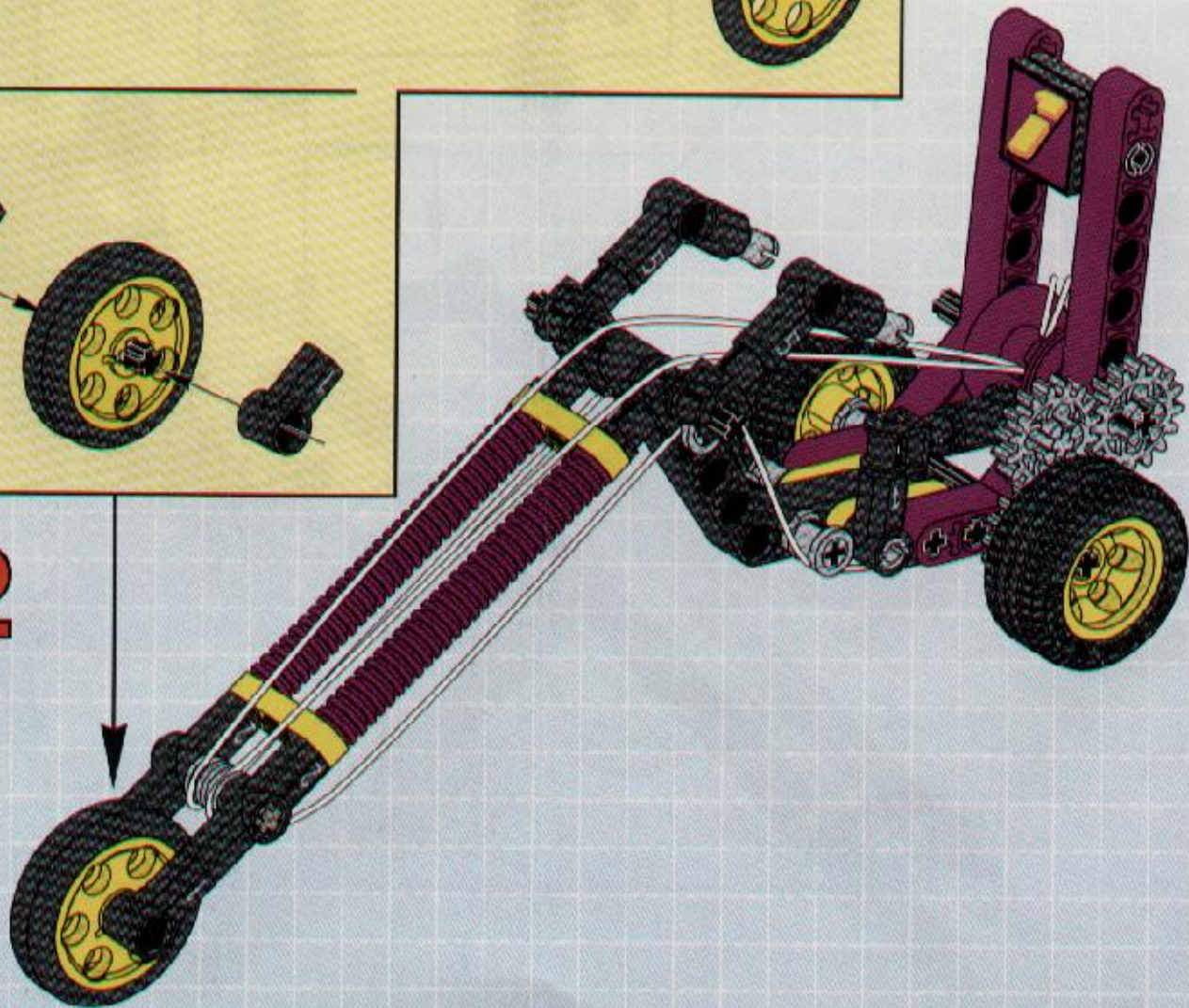

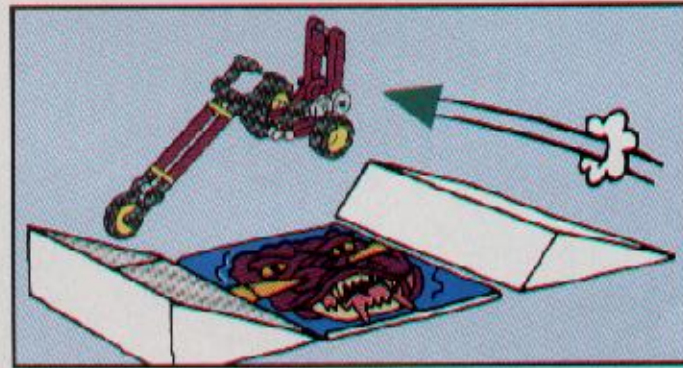
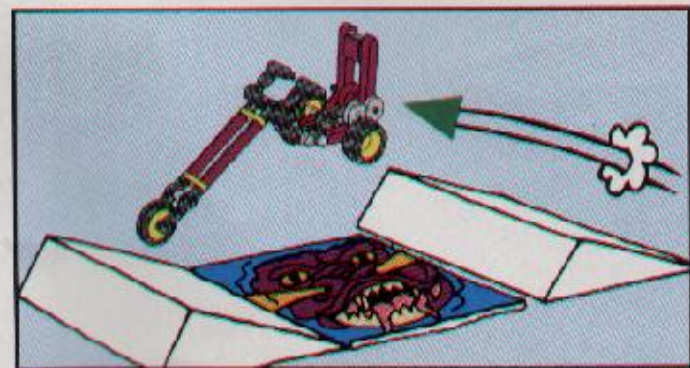
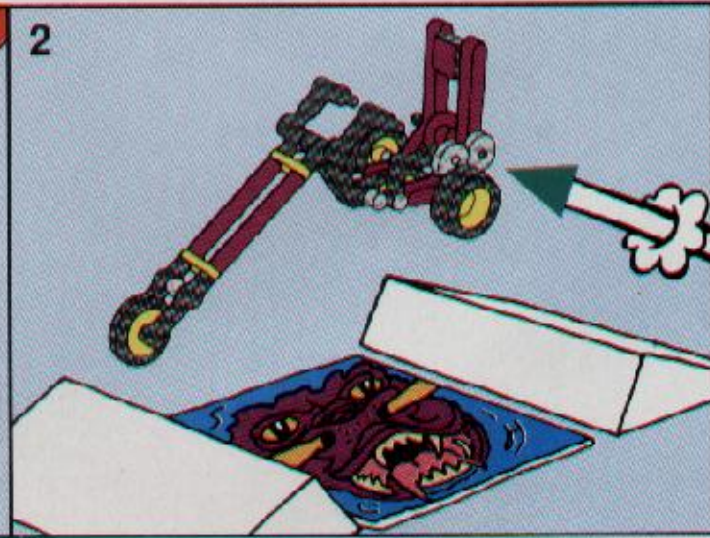
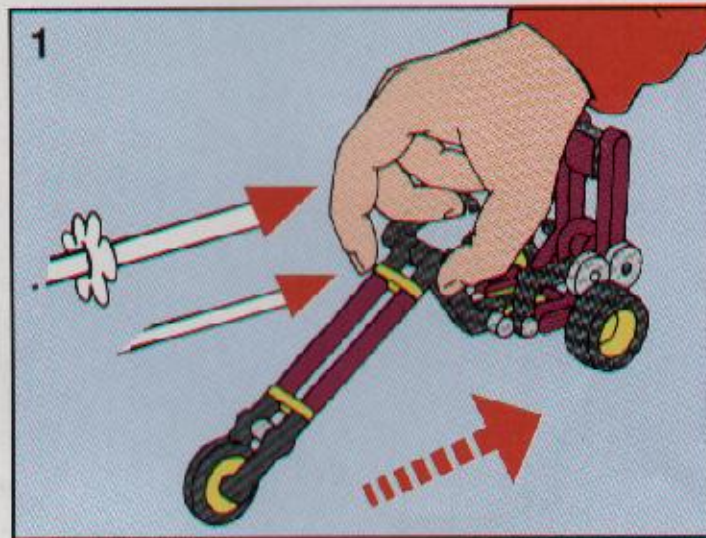
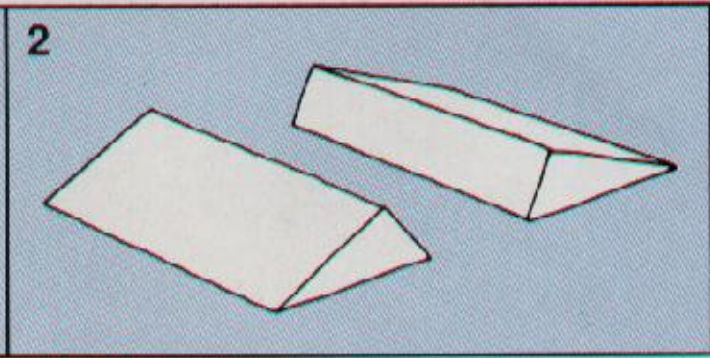
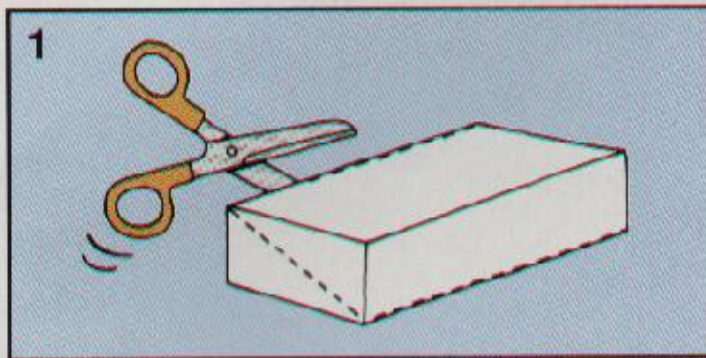





Technic

2854-2

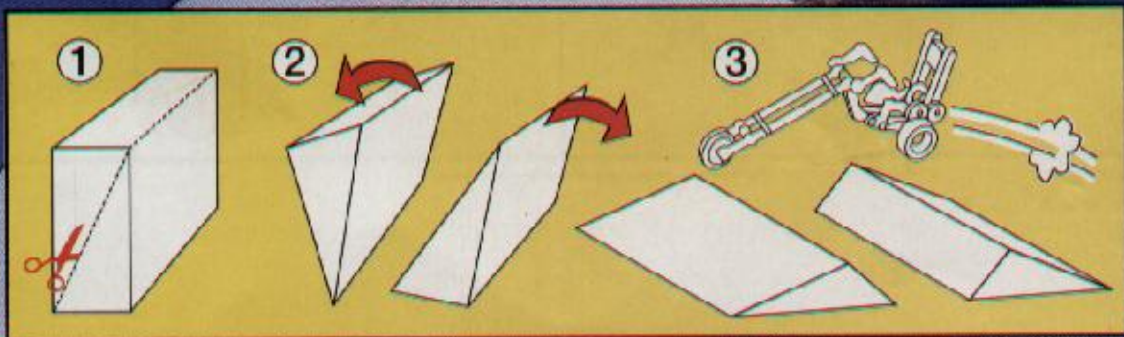
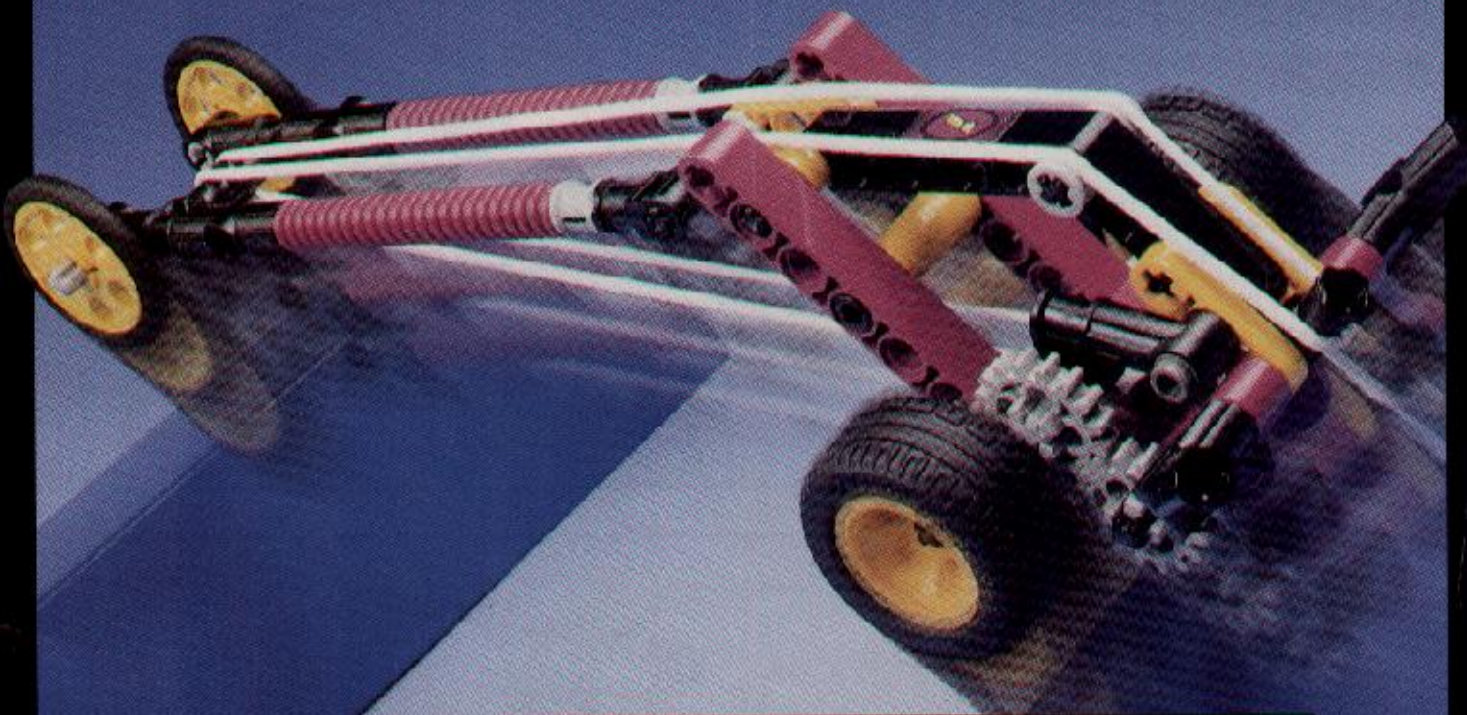

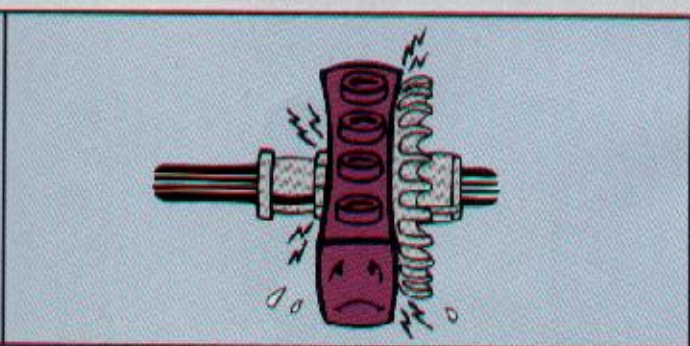
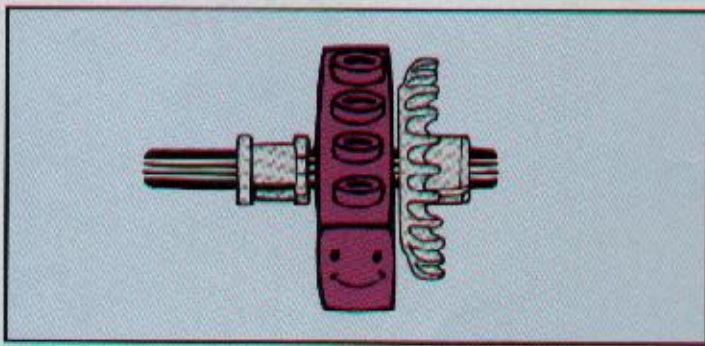
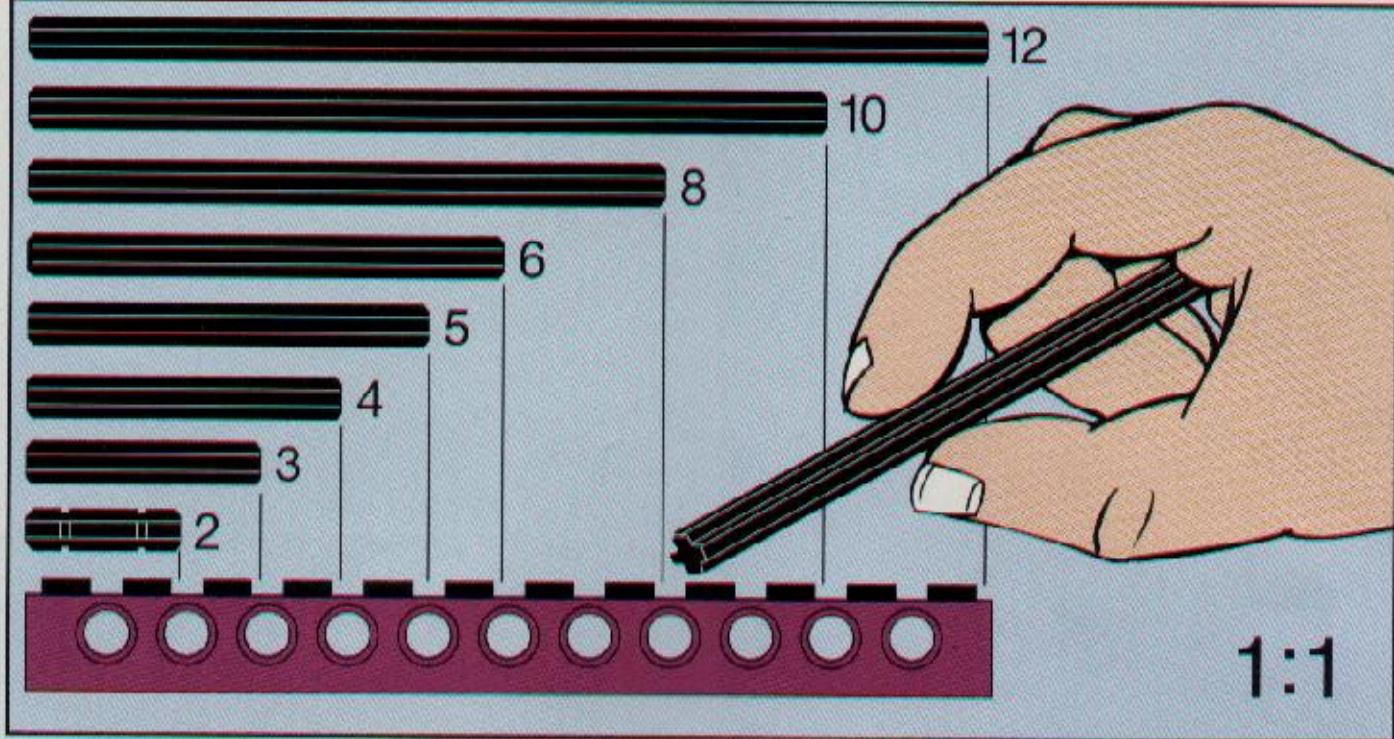

1

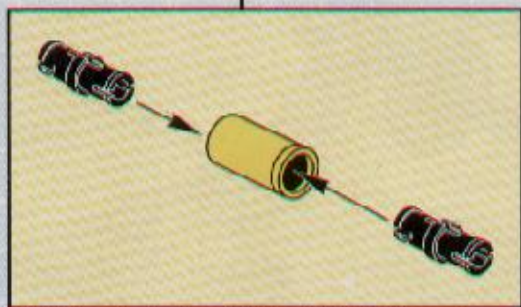
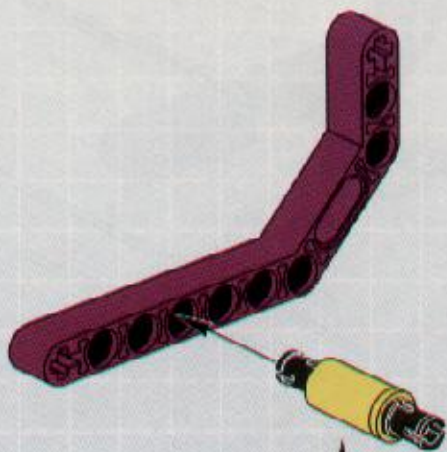

1

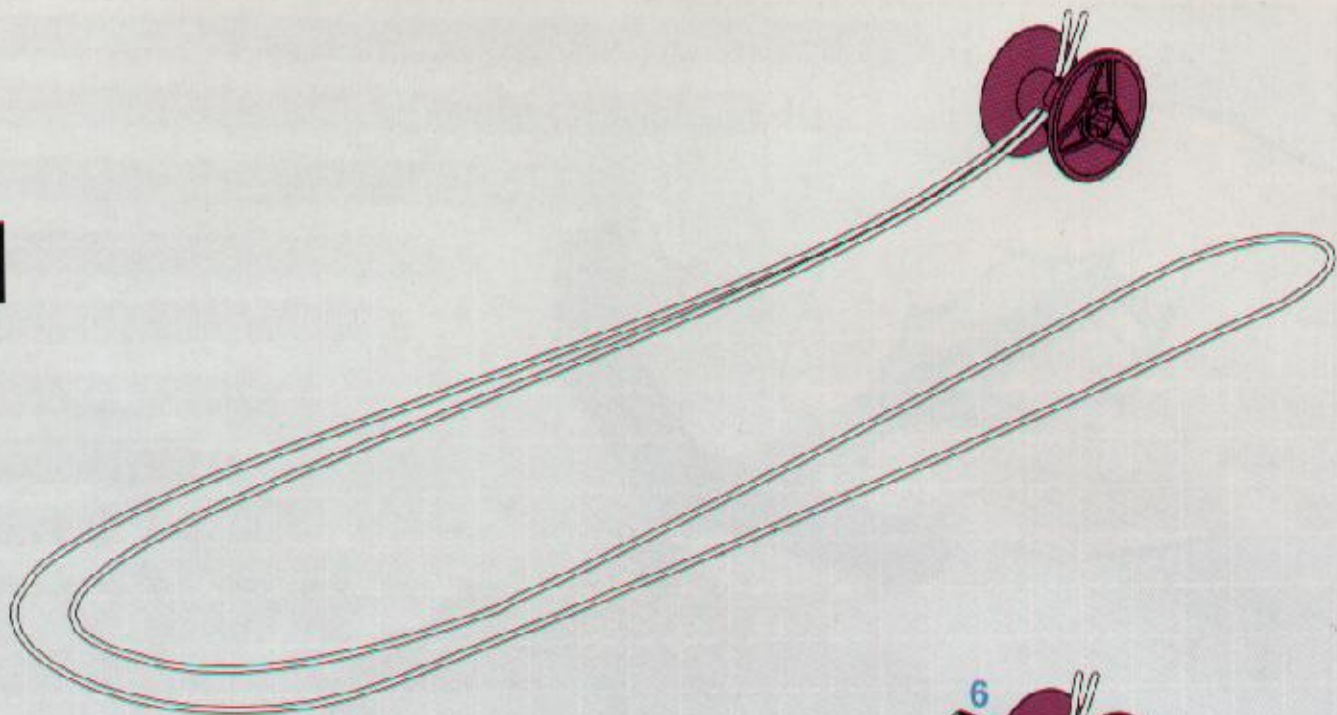

2



4

2

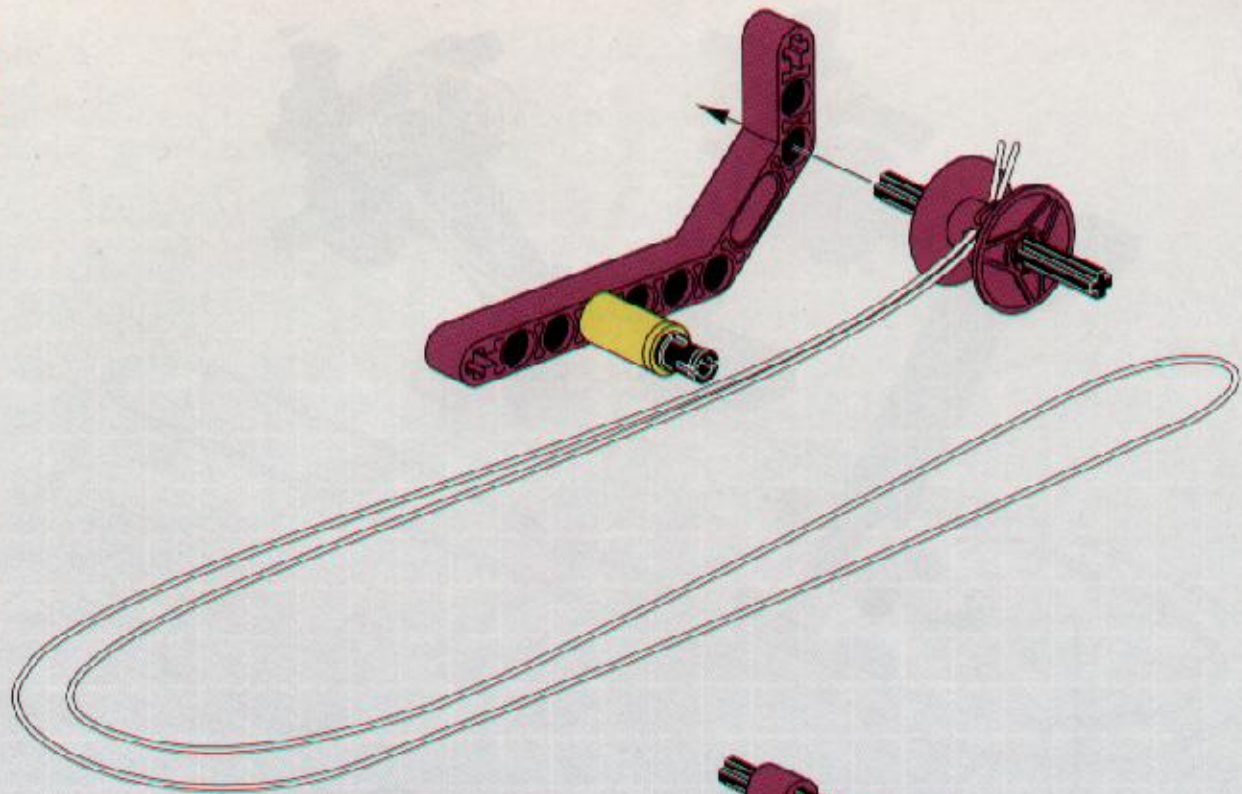

3

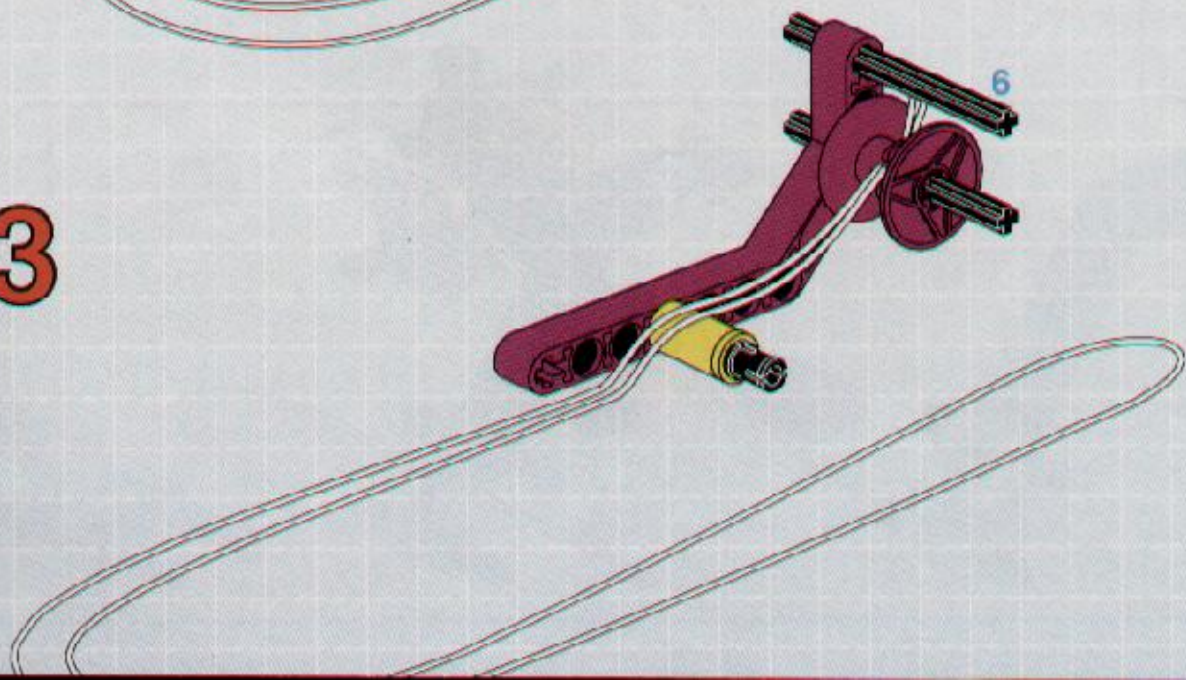

4

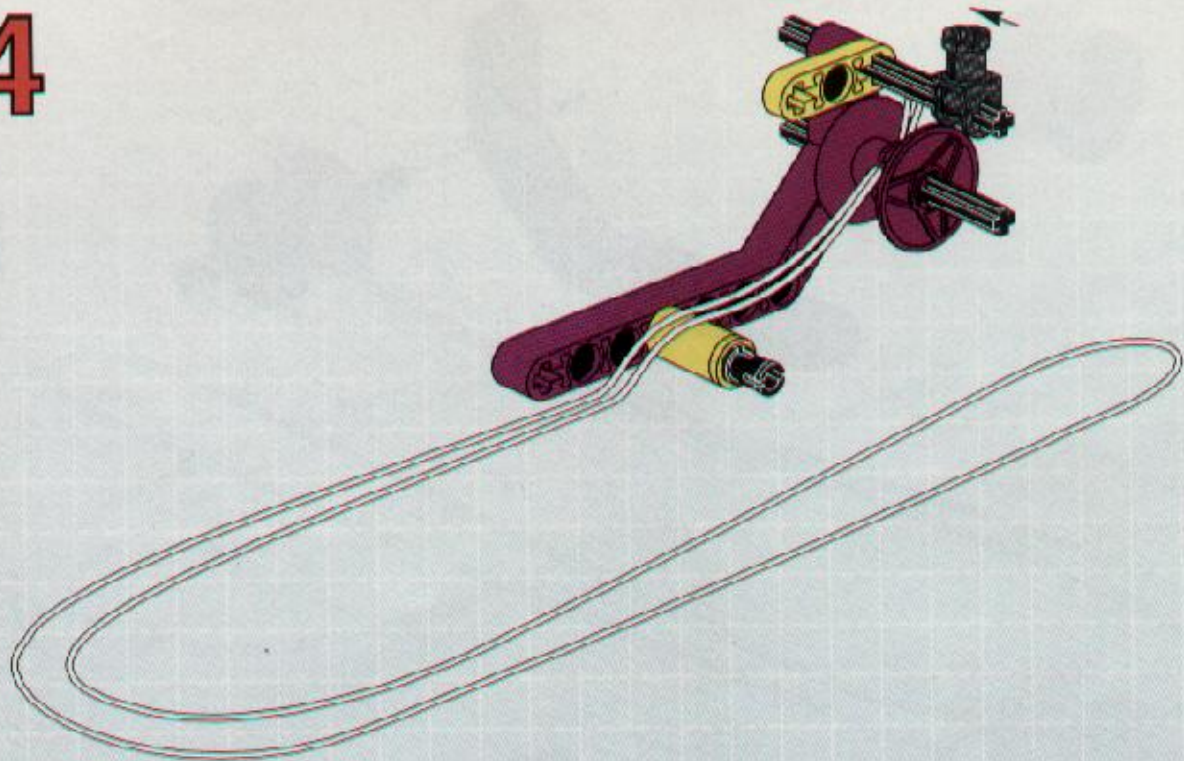

5

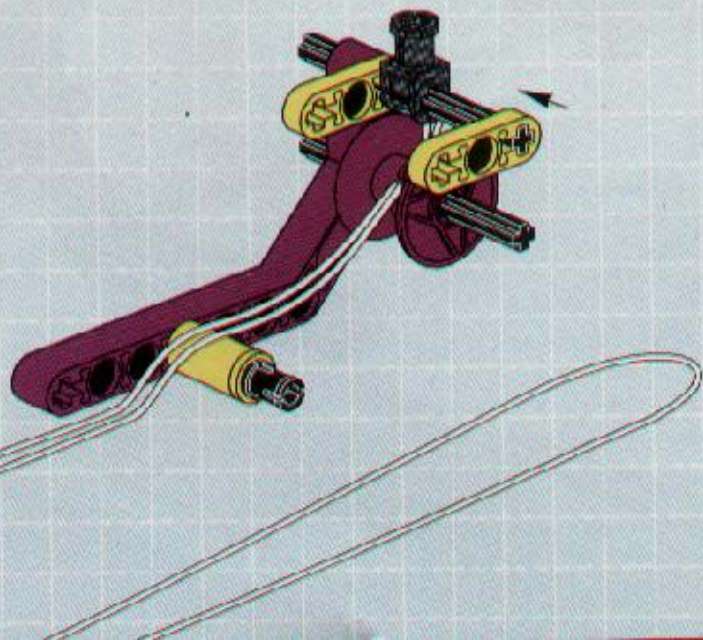

6

6

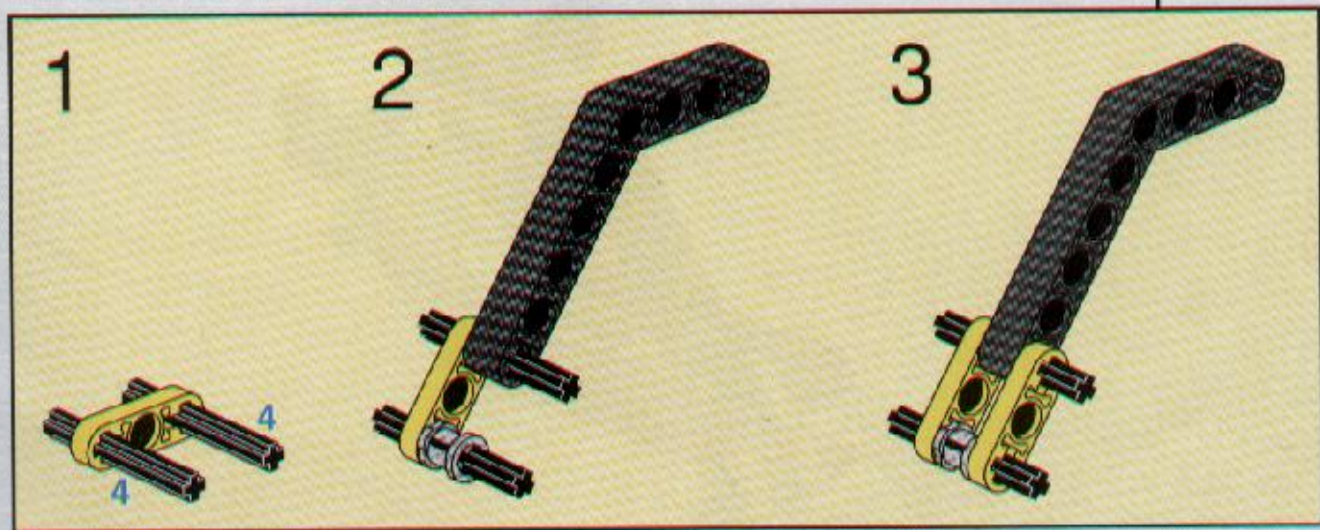
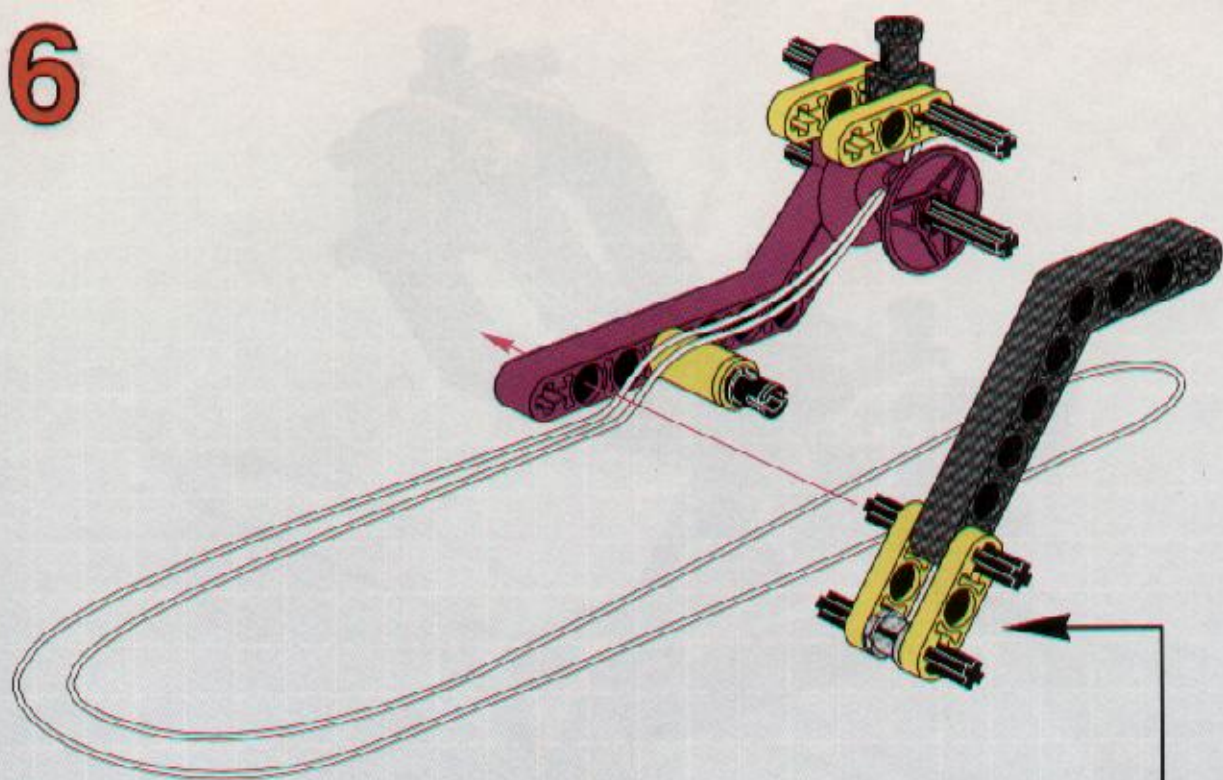

7

2

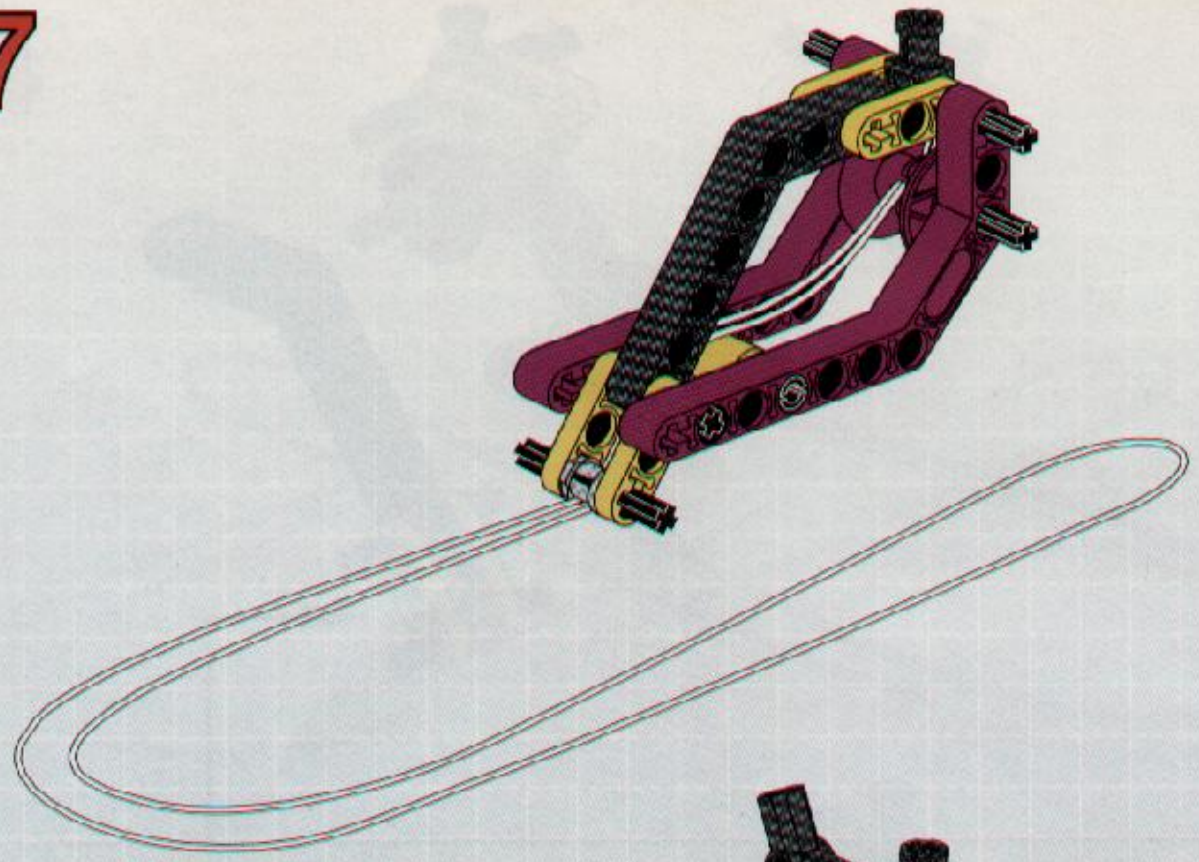

8

8

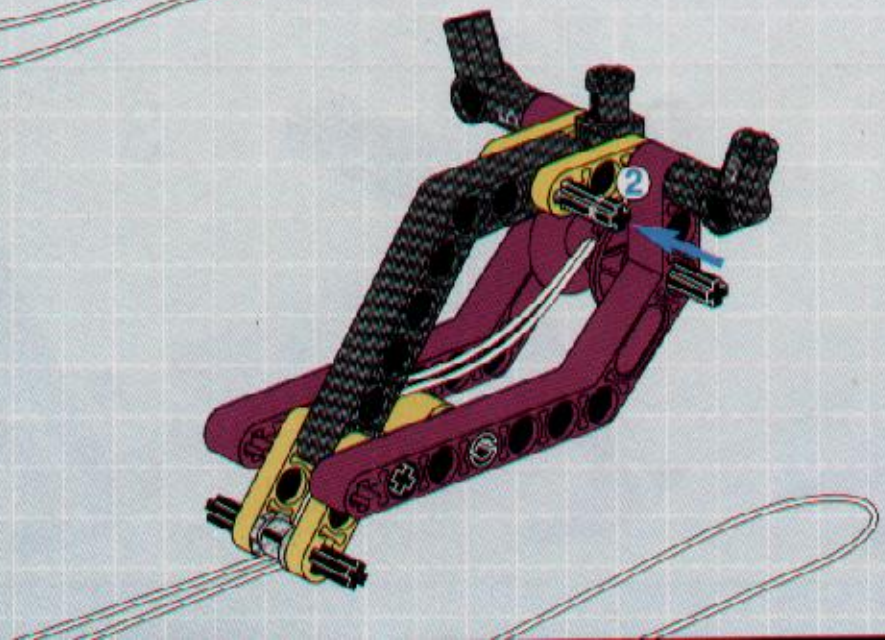

9

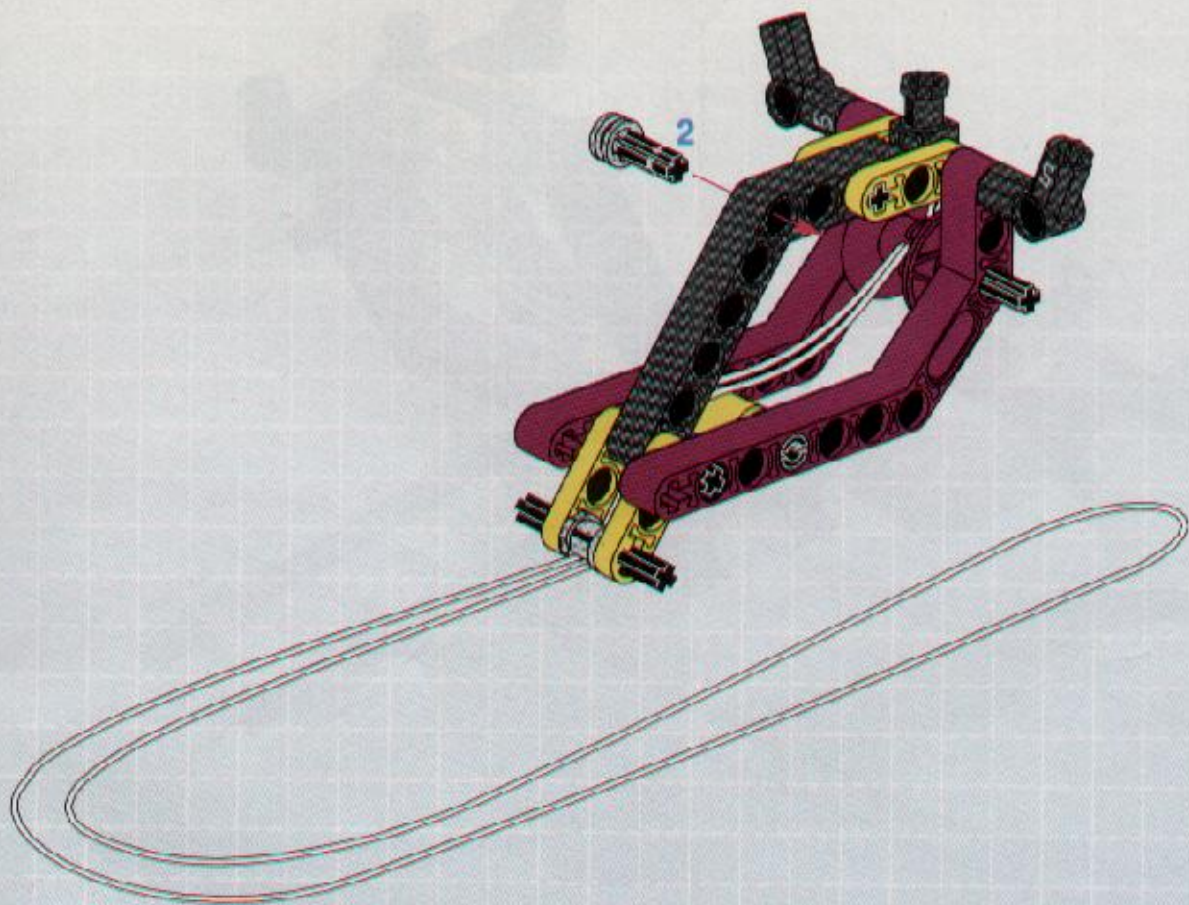

10

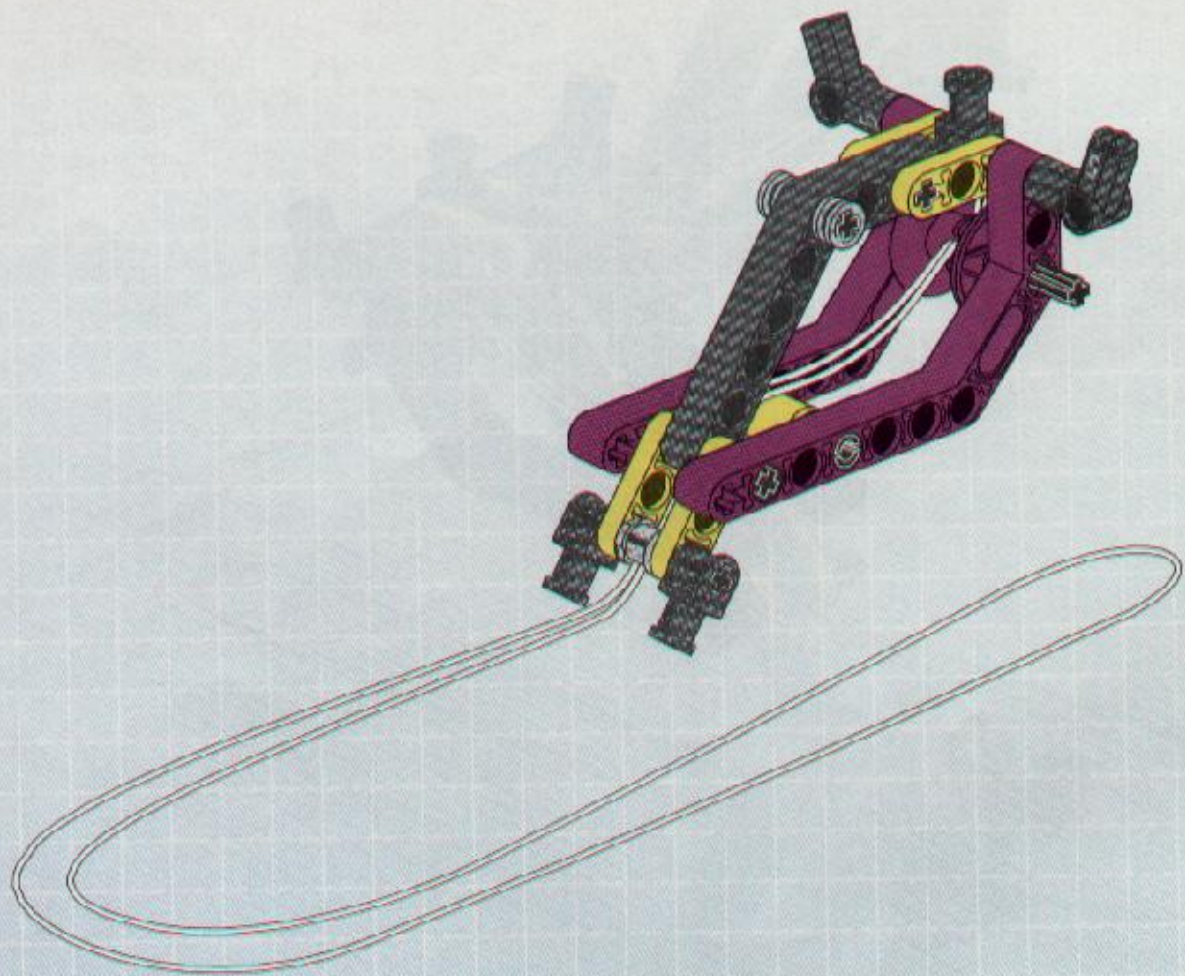

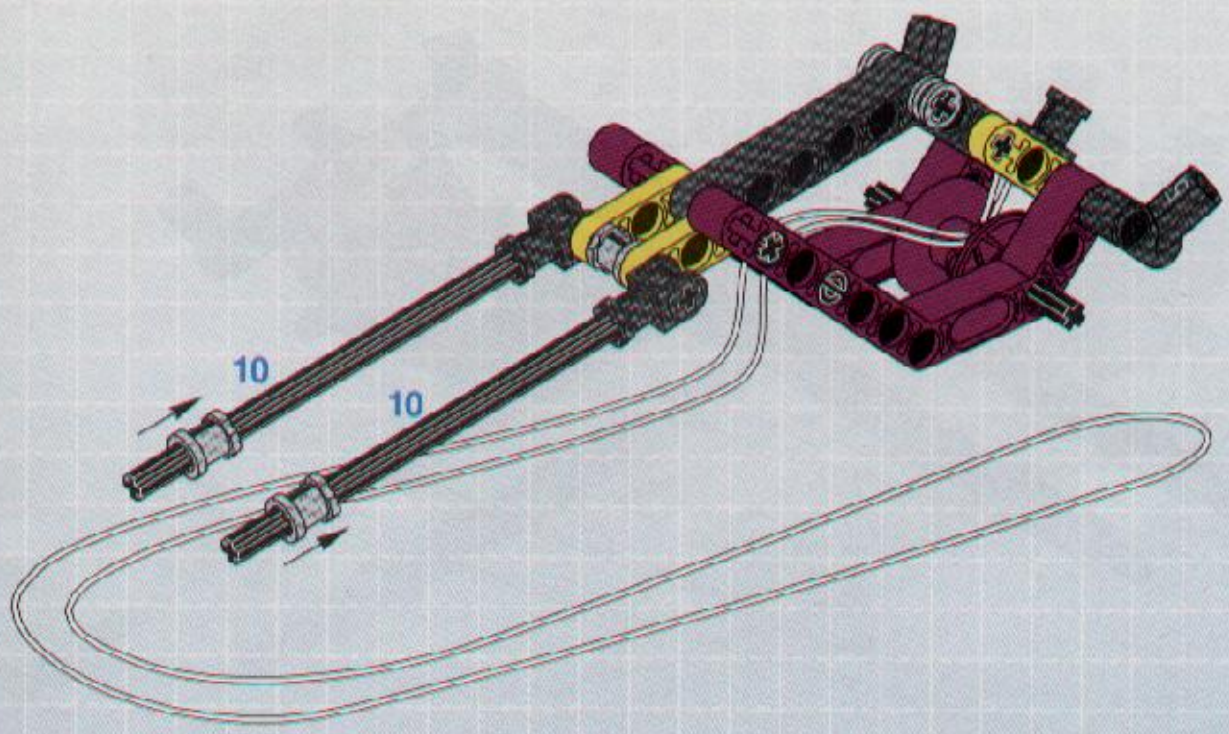

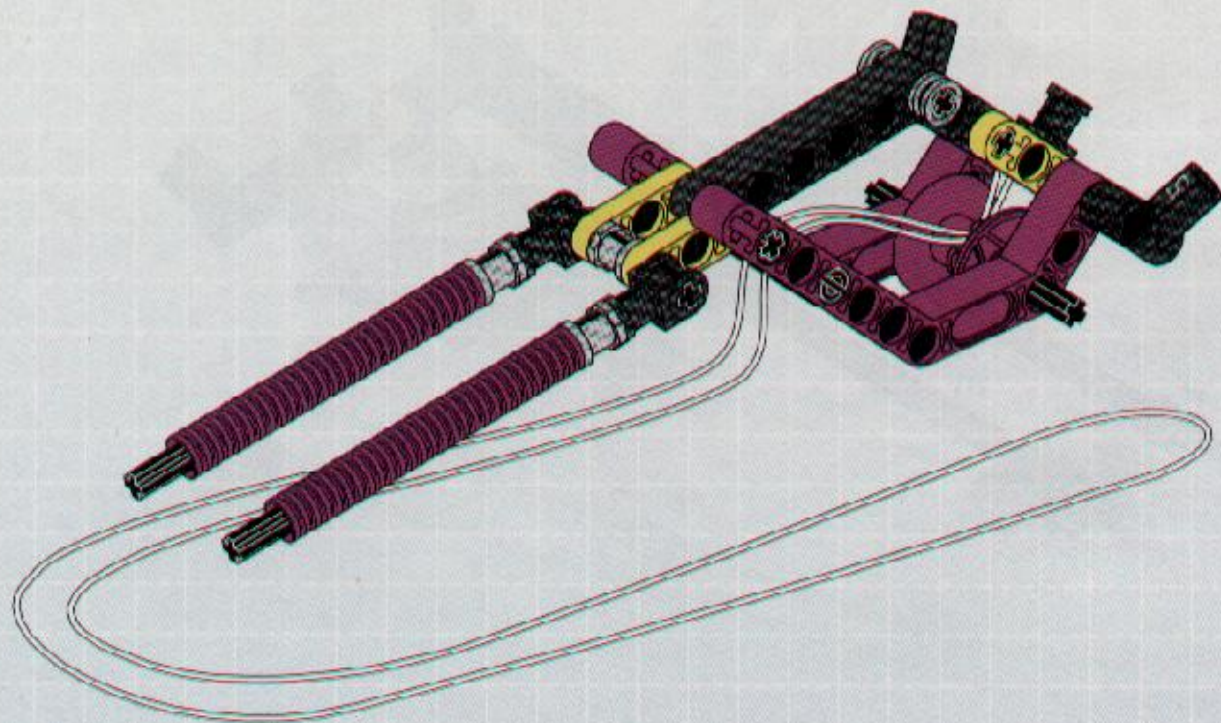

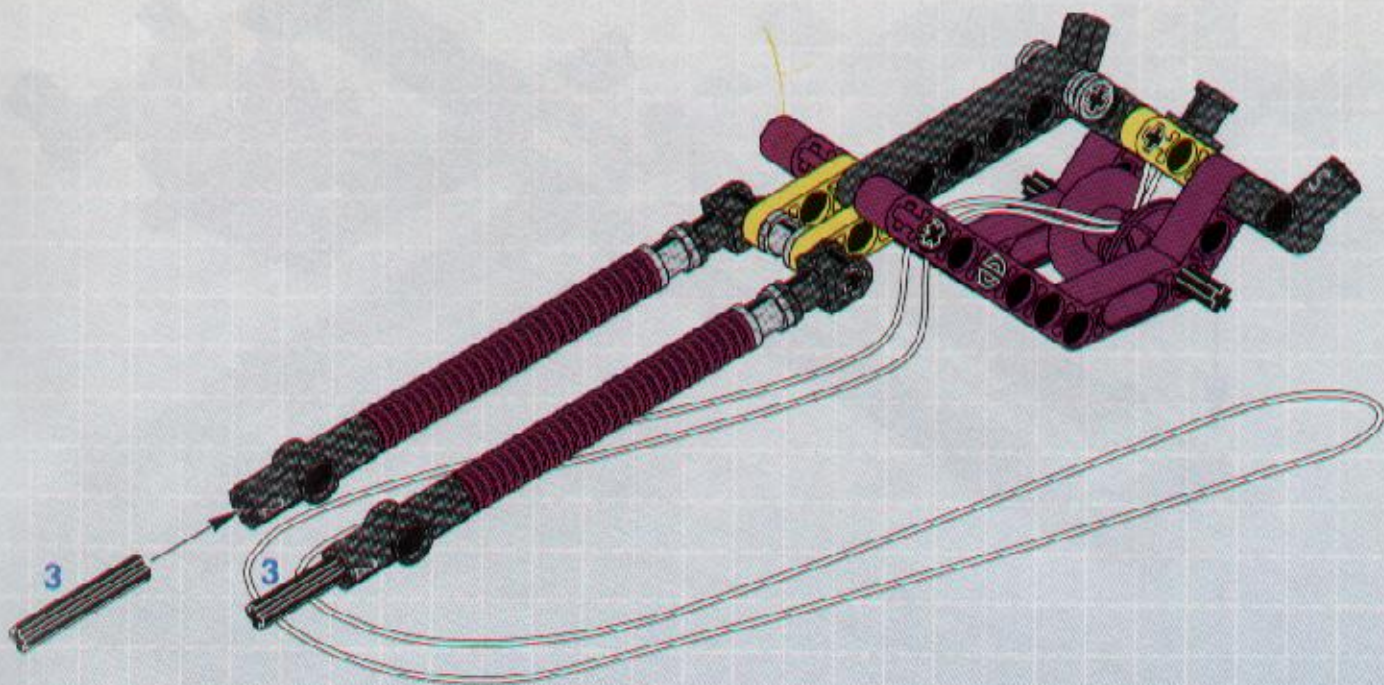

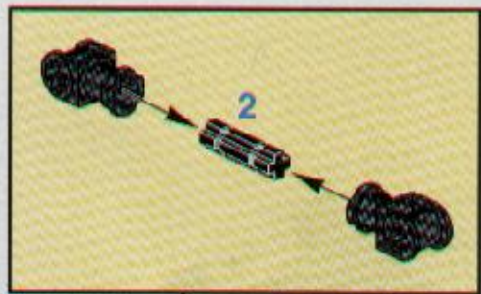

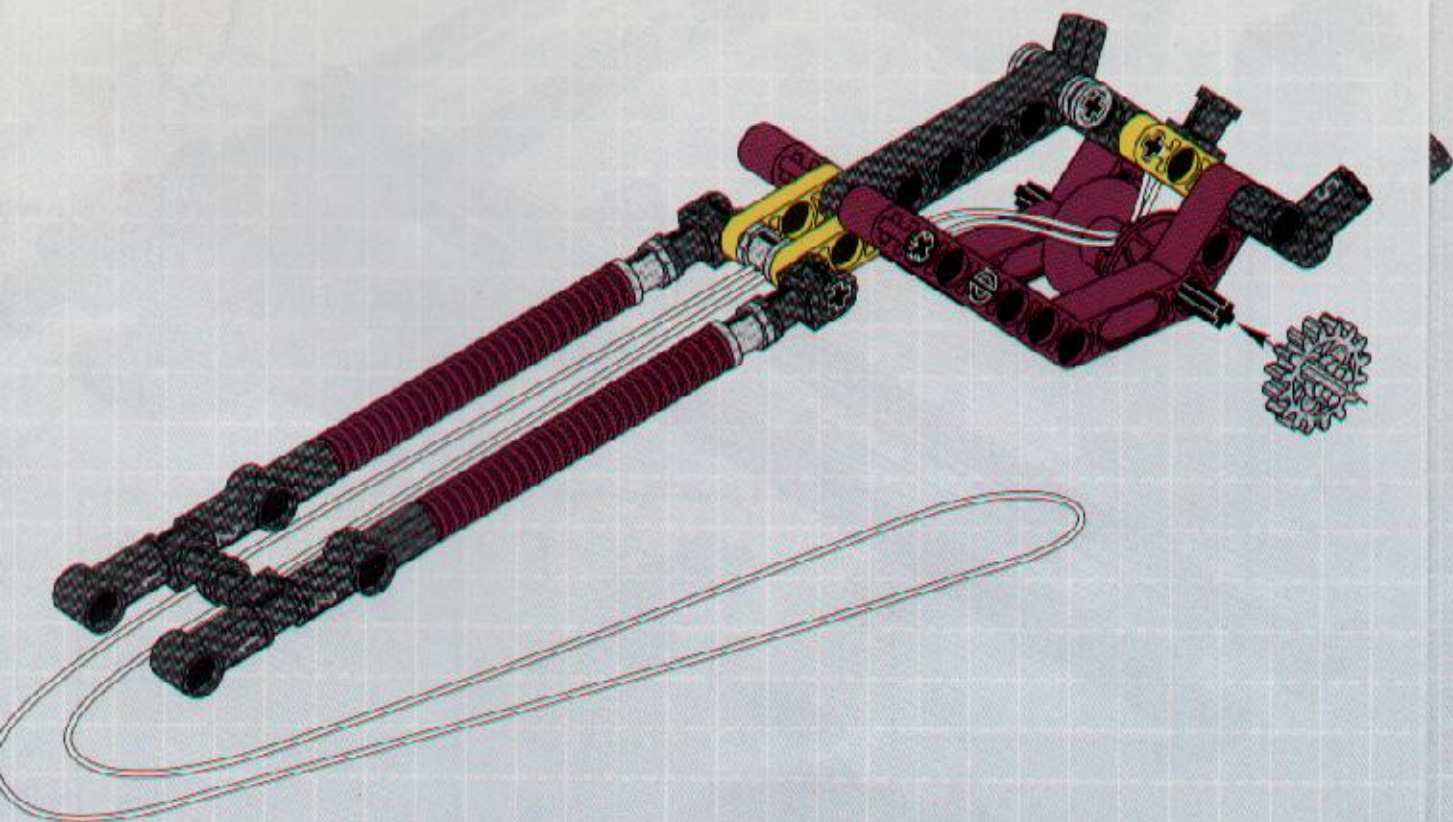

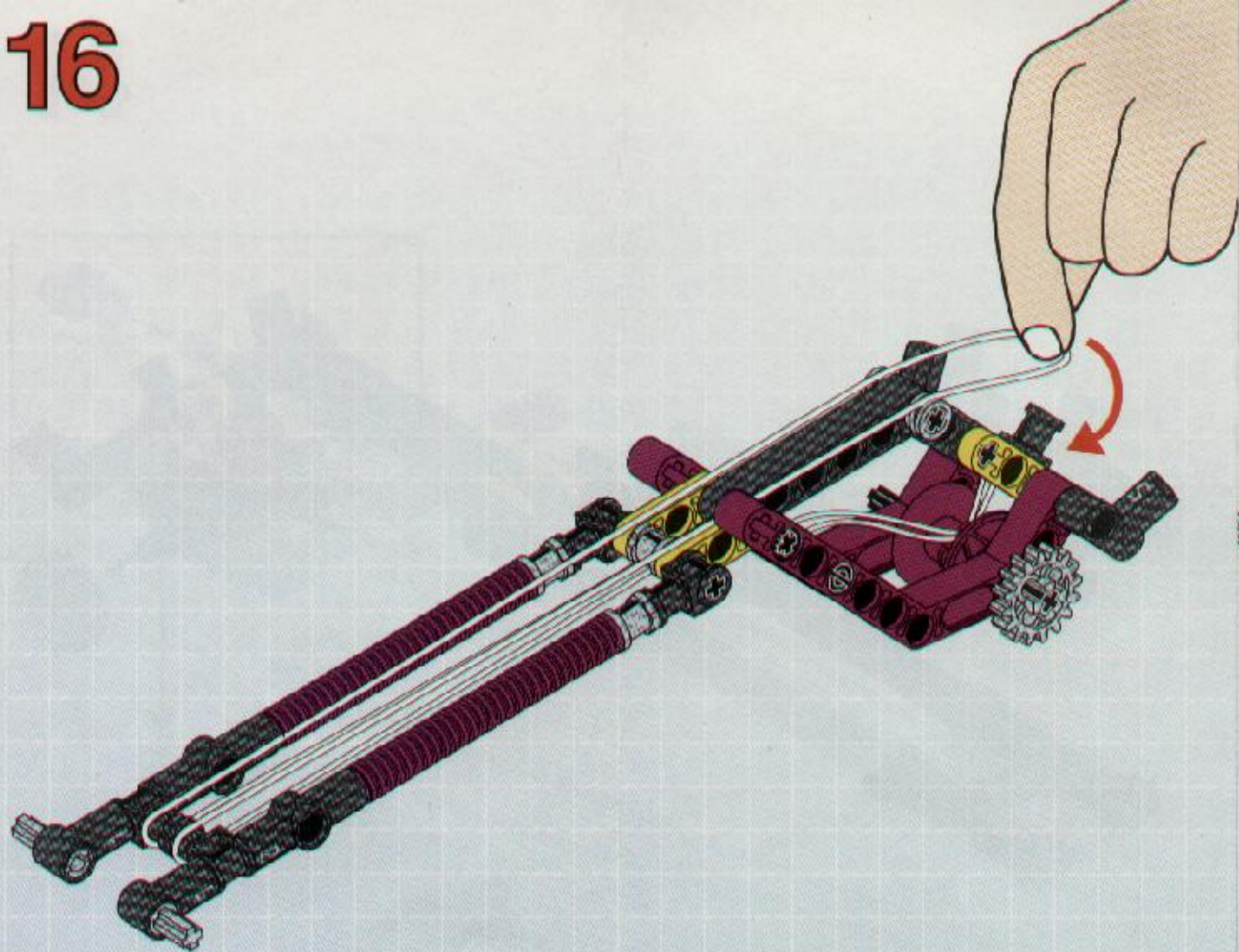

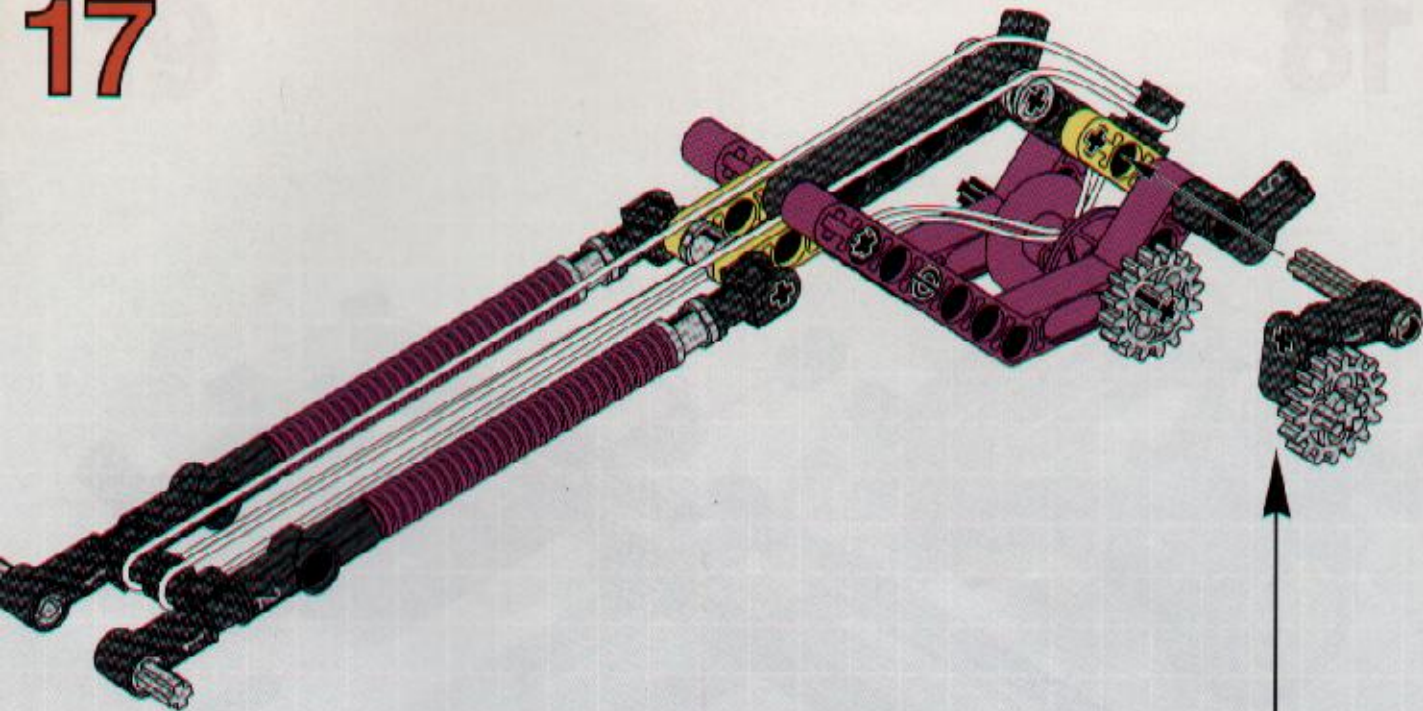

<p>1</p> <p>2</p>	<p>3</p> <p>4</p> <p>5</p>
<p>2</p> <p>3</p> <p>4</p> <p>5</p>	<p>5</p>

18

